

DISCUSSION PAPER SERIES

DP14916

IMMIGRANT INVENTORS AND DIVERSITY IN THE AGE OF MASS MIGRATION

Francesco Campo, Mariapia Mendola, Andrea
Morrison and Gianmarco Ottaviano

INTERNATIONAL TRADE AND REGIONAL ECONOMICS



IMMIGRANT INVENTORS AND DIVERSITY IN THE AGE OF MASS MIGRATION

Francesco Campo, Mariapia Mendola, Andrea Morrison and Gianmarco Ottaviano

Discussion Paper DP14916

Published 21 June 2020

Submitted 18 June 2020

Centre for Economic Policy Research
33 Great Sutton Street, London EC1V 0DX, UK
Tel: +44 (0)20 7183 8801
www.cepr.org

This Discussion Paper is issued under the auspices of the Centre's research programmes:

- International Trade and Regional Economics

Any opinions expressed here are those of the author(s) and not those of the Centre for Economic Policy Research. Research disseminated by CEPR may include views on policy, but the Centre itself takes no institutional policy positions.

The Centre for Economic Policy Research was established in 1983 as an educational charity, to promote independent analysis and public discussion of open economies and the relations among them. It is pluralist and non-partisan, bringing economic research to bear on the analysis of medium- and long-run policy questions.

These Discussion Papers often represent preliminary or incomplete work, circulated to encourage discussion and comment. Citation and use of such a paper should take account of its provisional character.

Copyright: Francesco Campo, Mariapia Mendola, Andrea Morrison and Gianmarco Ottaviano

IMMIGRANT INVENTORS AND DIVERSITY IN THE AGE OF MASS MIGRATION

Abstract

A possible unintended but damaging consequence of anti-immigrant rhetoric, and the policies it inspires, is that they may put high-skilled immigrants off more than low-skilled ones at times when countries and businesses intensify their competition for global talent. We investigate this argument following the location choices of thousands of immigrant inventors across US counties during the Age of Mass Migration. To do so we combine a unique USPTO historical patent dataset with Census data and exploit exogenous variation in both immigration flows and diversity induced by former settlements, WWI and the 1920s Immigration Acts. We find that co-ethnic networks play an important role in attracting immigrant inventors. However, we also find that immigrant diversity acts as an additional significant pull factor. This is mainly due to externalities that foster immigrant inventors' innovativeness. These findings are relevant for today's advanced economies that have become major receivers of migrant flows and, in a long-term perspective, have started thinking about immigration in terms of not only level but also composition.

JEL Classification: F22, J61, O31

Keywords: International Migration, Cultural diversity, Innovation

Francesco Campo - francesco.campo@unimib.it
Università degli Studi di Milano Bicocca

Mariapia Mendola - mariapia.mendola@unimib.it
Università di Milano–Bicocca

Andrea Morrison - a.morrison@uu.nl
Utrecht University

Gianmarco Ottaviano - gianmarco.ottaviano@unibocconi.it
Bocconi University and CEPR

Acknowledgements

We thank Dario Diodato, Michel Serafinelli, Alexander Whalley and seminar participants at LSE, Utrecht, Bocconi, Bicocca and Bari for useful comments and suggestions. We are grateful to Samuel Bazzi for sharing US-frontier data with us, and to Tanguy Millardet and Elham Talebbeydokhti for invaluable support with data preparation. Morrison acknowledges the Marie Skłodowska-Curie Individual Fellowships (H2020-MSCA-IF-2017 Project number: 789505) 'GOTaM Cities' for financial support. The usual disclaimer applies.

Immigrant Inventors and Diversity in the Age of Mass Migration*

Francesco Campo[†], Mariapia Mendola[‡], Andrea Morrison[§], Gianmarco Ottaviano[¶]

June 15, 2020

Abstract

A possible unintended but damaging consequence of anti-immigrant rhetoric, and the policies it inspires, is that they may put high-skilled immigrants off more than low-skilled ones at times when countries and businesses intensify their competition for global talent. We investigate this argument following the location choices of thousands of immigrant inventors across US counties during the Age of Mass Migration. To do so we combine a unique USPTO historical patent dataset with Census data and exploit exogenous variation in both immigration flows and diversity induced by former settlements, WWI and the 1920s Immigration Acts. We find that co-ethnic networks play an important role in attracting immigrant inventors. However, we also find that immigrant diversity acts as an additional significant pull factor. This is mainly due to externalities that foster immigrant inventors' innovativeness. These findings are relevant for today's advanced economies that have become major receivers of migrant flows and, in a long-term perspective, have started thinking about immigration in terms of not only level but also composition.

JEL codes: F22, J61, O31

Keywords: International Migration, Cultural Diversity, Innovation

*We thank Dario Diodato, Michel Serafinelli, Alexander Whalley and seminar participants at LSE, Utrecht, Bocconi, Bicocca and Bari for useful comments and suggestions. We are grateful to Samuel Bazzi for sharing US-frontier data with us, and to Tanguy Millardet and Elham Talebbeydokhti for invaluable support with data preparation. Morrison acknowledges the Marie Skłodowska-Curie Individual Fellowships (H2020-MSCA-IF-2017 Project number: 789505) 'GOTaM Cities' for financial support. The usual disclaimer applies.

[†]University of Milano Bicocca; email: francesco.campo@unimib.it

[‡]University of Milano Bicocca and IZA; email: mariapia.mendola@unimib.it.

[§]ICRIOS-Bocconi University and Utrecht University; email: andrea.morrison@unibocconi.it.

[¶]Bocconi University, BAFFI-CAREFIN, IGIER, CEP, CEPR and IZA; email: gianmarco.ottaviano@unibocconi.it.

1 Introduction

In recent years immigration has become the bogeyman of many politicians around the world who have gained national prominence by stirring anti-immigrant sentiment. Their rhetoric flies, however, in the face of several studies finding a positive impact of immigration on national and regional economies, with limited losses only for natives at the lower end of the skill distribution (Peri, 2016).¹ Yet, when it comes to immigrants at the higher end of the skill distribution, even anti-immigration politicians tend to fudge their rhetoric as the bulk of the evidence points to high-skilled immigrants boosting innovation and productivity, mainly through the increased quantity of high-skilled individuals pursuing innovative work (Kerr et al., 2016).² In this respect, a possible unintended damaging consequence of anti-immigrant rhetoric and the policies it inspires is that they may put high-skilled immigrants off more than low-skilled ones at times when countries and businesses intensify their competition for global talent (Kerr, 2018). To reduce the fallout, several countries have introduced discriminatory policies that, to different degrees, favor high-skilled immigrants while penalizing low-skilled ones (Kerr et al., 2016). These policies rest on the implicit assumption that the supply of high-skilled immigrants to any given discriminating country is largely inelastic and high-skilled immigrants are indifferent to the presence of other immigrants. However, if this assumption failed and high-skill immigrants instead valued the presence of other immigrants, harsh restrictions on low-skill inflows could end up discouraging also high-skilled inflows with far reaching implications for immigration policy design.

The aim of this paper is to investigate the validity of the foregoing argument exploiting the unique experience of the United States during the Age of Mass Migration from 1870 to 1920, when more than 30 million people migrated to the US mainly from different parts of Europe (Abramitzky and Boustan, 2017; Hatton and Williamson, 1998; Bandiera et al., 2013). What makes this period of massive inflows of foreigners particularly attractive for our purposes is the high variation in the

¹The contrast between attitudes and economic outcomes is reminiscent of what happened in the Age of Mass Migration, when in the US anti-immigrant sentiment took control of the political agenda despite the positive economic effects of immigration on employment and industrial production (Tabellini, 2020). It was indeed in the Age of Mass Migration that America became the world’s prominent industrial nation (Hughes, 2004).

²Arguably the upper tail of the skill distribution can never be dense enough. Mokyr and Voth (2009) conclude that the Industrial Revolution was driven by the ingenuity and technical ability of a minority (see also Squicciarini and Voigtländer (2015); Mokyr (2005)). Foreign-born inventors played a crucial role in the making of the United States as an innovation powerhouse by bringing new knowledge from their countries of origin (Diodato et al., 2018; Moser et al., 2014) and contributing to the long-term technological development of the US innovation system (Akcigit et al., 2017b). Nowadays it is largely recognised that science, technology, engineering, and mathematics (STEM) workers are fundamental inputs for innovation and growth (Peri et al., 2015; Hanushek and Kimko, 2000; Bloom and Van Reenen, 2007; Gennaioli et al., 2013).

number and the mix of immigrants both across US geographic administrative units (‘counties’) and over time. While most immigrants were relatively low-skilled, in the order of thousands were inventors who represented the top tail of foreign human capital and massively contributed to the rising global dominance of US technology (Akcigit et al., 2017a; Diodato et al., 2018; Moser and San, 2019). This foreign talent transformed US science and engineering, reshaped the economy, and influenced society at large (Kerr, 2018).

Talented immigrant inventors are the subject of our analysis. In particular, we want to understand where they chose to reside, whether the local presence of other immigrants was a pull factor for their choices, and, if so, why that was the case. On the one hand, immigrant inventors could benefit from the heterogeneous set of skills and ideas associated with immigrant diversity. If these were complementary to their own skills in knowledge production, foreign inventors should self-select into more diverse locations in order to foster their productivity. A more diverse environment could also promote the circulation of ideas and knowledge spillovers, as well as a better understanding of the state of technology. On the other hand, diversity may also be conducive to an environment that is more tolerant toward creative destruction and thus more fertile for inventors to grow their own innovations. At the same time, differently from other immigrants, inventors may be less exposed to the costs of navigating diversity thanks to better communication and cognitive skills that lower linguistic and cultural barriers (Giuliano, 2007; Algan and Cahuc, 2010). While there is already evidence on the regional distribution and location choices of immigrants in general – with co-ethnic networks, wages and economic prosperity playing a prominent role among pull factors (McKenzie and Rapoport, 2007) – much less is known about the specific role of diversity in attracting immigrant inventors. Existing works studying immigrant inventors from an historical perspective (such as Moser et al. (2014); Diodato et al. (2018); Akcigit et al. (2017b) mainly focus on the impact on receiving economies’ technological trajectories. We take, instead, the reverse angle and investigate the impact of receiving economies’ characteristics on immigrant inventors’ location choice. Moreover, while those studies focus either on a single ethnic group (e.g. Germans) or pool all ethnic groups together, we are interested in a richer characterization of immigrant diversity.

To guide our empirical investigation we first develop a simple model of immigrant inventors’ location decisions across US counties in the wake of Roback (1982) and Ottaviano and Peri (2005, 2006). Taking the decision to migrate to the US as predetermined, in the model immigrant inventors freely select the county to work and live in based on both labor market and quality of life considerations. They are employed in a perfectly competitive innovation sector whose patents

feed the production of a final aggregate good, which is itself produced under perfect competition and freely traded nationwide. Immigrant inventors consume the final good as well as a bundle of locally supplied non-tradable services. These services are also used in the innovation sector to complement immigrant inventors' employment.³ The presence of other immigrants affects immigrant inventors' location choices through the supply of non-tradable services and two localized externalities. Specifically, it affects their productivity through a 'production amenity' and their utility through a 'consumption amenity'. In equilibrium immigrant inventors are indifferent between alternative counties as the net effect of the two externalities is capitalized in the price of local non-tradable services, which itself depends on the local density of immigrant inventors. For instance, should immigrant inventors favour a certain county over the average county, their higher density in the former would drive the local price of non-tradable services above the national average. For them to be nonetheless happy with locating there, it must be that they enjoy a localized production amenity or a localized consumption amenity that compensates them for more expensive services. If their productivity is above the national average, this means that they are compensated by a production amenity; if their productivity is below the national average, this means that they are compensated by a consumption amenity. The model's empirical implications are twofold in terms of assessing the role played by other immigrants in the location decisions of immigrant inventors. First, all the rest given, if immigrant inventors flock to (away from) counties where other immigrants are concentrated, this means that they are attracted (repelled) by an overall amenity (disamenity). Second, if in the case of amenity in those counties immigrant inventors are more (less) productive, this means that they are attracted by a production (consumption) amenity. Analogously in the case of disamenity, if immigrant inventors are more (less) productive, it means that they are repelled by an immigrant consumption (production) disamenity.

We test these implications on a dataset drawing from two sources. For the outcome variables of immigrant inventors (presence and productivity), we exploit an original dataset compiled by [Diodato et al. \(2018\)](#), which identifies immigrant inventors in historical patent documents of the United States Patent and Trademark Office (USPTO). Our focus is on immigrant inventors and patentees arrived in the US in their adult age as their skills are more likely related to their background before migrating. The dataset has been generated through a text-mining algorithm, analogous to the one described in [Petralia et al. \(2016\)](#), and a semi-automated procedure that

³Non-tradable services are aimed to capture in a simple way the fact that geographic locations provide different levels of access to financial and physical capital, technology, complementary institutions, and workers, which all impact the quality and productivity of the available jobs ([Moretti, 2012](#)). Moreover, many high-skilled occupations show agglomeration effects, where an individual worker's productivity is enhanced by being near to or working with many other workers in similar sectors or occupations ([Glaeser and Resseger, 2010](#)).

extracts detailed information, from digitalized patent records, on both country of origin and county of residence for inventors arrived in the US between 1870 and 1940. It contains about 43,000 patents granted to about 20,000 immigrants together with the patentees’ counties of residence as reported in the patent records.

For the explanatory variables related to county characteristics, the foregoing pieces of information are matched with NHGIS IPUMS county-level decennial census files (Manson et al., 2019) between 1870 and 1930.⁴ We focus on counties that in each census year have at least 2,500 inhabitants (which is the IPUMS threshold used to distinguish ‘urban’ from ‘rural’ counties) and at least one foreign-born resident. This generates a balanced panel of about 2,900 counties for census years 1870 to 1930. For each county c we obtain the shares of immigrants in the local population by country of origin e . We then use these shares to compute our main variables explaining immigrant inventors’ outcomes in county c from country e : the share of all immigrants from country e in the population of county c , the share of countries other than e in the total immigrant population of county c , and the dispersion of county c ’s immigrants across countries of origin other than e . The first explanatory variable is meant to capture the role of co-ethnic networks, which have been identified as important drivers of immigrants’ location choices (McKenzie and Rapoport, 2007). The second and third explanatory variables are meant to capture the role of ‘diversity’ in the local population, which has also been shown to affect local economic performance (Ottaviano and Peri, 2005, 2006; Ager and Brückner, 2013). We refer to the share of migrants in the population as diversity ‘between’ natives and immigrants (given that the latter are a minority), and to the dispersion of immigrants across countries of origin as diversity ‘within’ immigrants (Alesina et al., 2016; Suedekum et al., 2014; Docquier et al., 2018; Bahar et al., 2020).⁵

We then assess the impacts of our explanatory variables measured in each census year on the change in immigrant inventors’ outcomes in the subsequent decade. This implies that the last census year we consider for the explanatory variables is 1930 and the last decade we consider for the outcomes is 1930-1940. We exploit variation in co-ethnic networks and diversity across counties and ethnicities over time.⁶ The unit of analysis is the sub-population cell defined by county of residence

⁴The decennial Census files are available on IPUMS NHGIS site: <https://data2.nhgis.org/main>.

⁵These studies are interested in the impact of immigrant diversity on economic productivity and growth. At the local level this issue has been studied, among others, by Ottaviano and Peri (2005, 2006) and Ager and Brückner (2013). At the firm or team level it has been investigated, among others, by Ozgen et al. (2014), Boeheim et al. (2012), Kahane et al. (2013) and Kemeny (2017). Differently, here we are interested in whether immigrant diversity attracts or repels immigrant inventors.

⁶In USPTO data immigrant status is identified from foreign nationality. Differently, in census data it is identified from foreign birthplace. Accordingly, the co-ethnic network of immigrant inventors with ethnicity e consists of all immigrants born in the foreign country the immigrant inventors were national of when they were granted their first

c and ethnicity e and we study how within-cell changes in co-ethnic networks and diversity affect within-cell changes in immigrant inventors' outcomes. As immigrants are not randomly assigned across counties, but rather self-select according to individual and local factors, OLS estimates would be biased if unobserved (county or ethnicity) time-varying factors simultaneously affected immigrants' local presence, ethnic composition and innovation activity. Moreover, local innovation shocks, as well as the inflows of immigrant inventors, may affect immigration and ethnic diversity if their economic impact results in significant labour demand shifts at county level and these are serially correlated. On the one hand, technological shocks to local productivity may attract or repel both immigrants and natives, but may disproportionately affect the location choices of the former if these are more mobile than the latter (Kerr et al., 2016). This confounding factor would generate an upward bias in the estimated correlation between diversity and inventors' outcomes (Ottaviano and Peri, 2005, 2006; Ager and Brückner, 2013). On the other hand, it has been argued that low-skilled immigration in the US changed the scale of production by stimulating labor complementary inventions (Acemoglu, 2010; Doran and Yoon, 2018). Conversely, innovations may foster labor-saving technological change, hence reducing diversity through the displacement of low-skilled immigrants. This reverse causality channel would generate a downward bias in the estimated correlation between diversity and inventors' outcomes. However, the presence of immigrant inventors may also foster local productivity and growth (Kerr et al., 2016) so that their location choices may affect the location choices of other immigrants by activating the local economy (Abramitzky et al., 2019; Romer, 1990; Zucker et al., 1998; Jaffe et al., 2001; Kerr and Lincoln, 2010; Hunt, 2011). This additional channel of reverse causality would lead to an upward bias in the estimated correlation between diversity and inventors' outcomes.

We deal with these potential biases in two ways. First, as immigrants tend to cluster along ethnic lines, we construct a set of shift-share instrumental variables for each potentially endogenous explanatory variable following the canonical approach based on pre-existing immigrant settlements (Card, 2001). Second, we exploit the quasi-experimental variation provided by the breakout of WWI and the Immigration Acts passed in 1921 and 1924. These acts restricted the number of new immigrants through quotas based on their birthplace and de facto ended the Age of Mass Migration (King, 2009; Ager and Hansen, 2017; Tabellini, 2020). Discrimination by birthplace exogenously changed the ethnic mix of immigrants. For example, while immigration from Asia was banned and arrivals from Italy dropped by more than 90 percent, immigration from Britain and Ireland fell by less than 20 percent. The introduction of the quota system significantly affected also the inflows of scientists (Moser and San, 2019). We then use county-by-ethnicity fixed effects

US patent.

to control for variation in local pull factors varying across ethnic groups (e.g. between Germans and Italians in the same county). These fixed effects also absorb variation in static county-specific pull factors as well as ethnic time-invariant factors. State-by-year fixed effects further control for changes in the composition of immigrants over state-time that are shared across ethnic groups. Finally, we also control for county-by-ethnicity (linear) time trends, in order to account for any cell-specific linear trajectory over time.

We find that co-ethnic networks play an important role in attracting immigrant inventors. However, ‘between’ and ‘within’ diversity also acts as a significant pull factor with the dominant driving force identified in production rather than consumption amenities. These findings are robust to checks of instruments’ validity and to the inclusion of potential confounding factors such as counties’ population (Ager and Brückner, 2013) and exposure to the American frontier (Bazzi et al., 2017). Our findings are relevant for today’s advanced economies that have become major receivers of migrant flows and, in a long-term perspective, have started thinking about immigration not only in terms of its level but also in terms of its composition.

The rest of the paper is organized as follows. Section 2 provides a brief account of the historical backdrop. Section 3 presents the model that informs our empirical analysis. Section 4 introduces our dataset. Section 5 describes our empirical strategy. Section 6 discusses our findings. Section 7 presents the robustness checks. Section 8 offers some concluding remarks.

2 Historical Context

Immigration to the US during the Age of Mass Migration (1870-1920) is remarkable for many reasons. First, it is estimated that more than 30 million people migrated, which makes this period the one with the highest amount of immigrants in US history (Hatton and Williamson, 1998). Mass migration ended by the 1920s, when country specific quotas were enforced (more details below). By this time, the share of immigrants had reached its highest peak at 14% of the total US population.

Second, immigration originated prevalently from Europe. However, differently from previous inflows, immigrants were sourced from a wide variety of countries and also from different regions within each country. Diversity was spurred by several consecutive waves of immigration. These started in the early nineteenth century with the migration of northern Europeans, prevalently from Ireland, Germany and England. By 1880 the composition of inflows shifted towards Germans and

Scandinavians. By the end of these first waves the immigrant stock in the US consisted prevalently of northern and western Europeans. Towards the turn of the century a new wave of immigration brought to the US mainly eastern and southern Europeans, who quickly reached a share of the total stock of immigrants similar to the previous immigrant waves (roughly around 40% of the foreign born population) (Abramitzky and Boustan, 2017).

Third, the newly formed immigrant communities in the US were highly clustered in space, and formed ethnic enclaves in cities and regions. (Abramitzky and Boustan, 2017) provide a visual representation of the geographical distribution of the main immigrant nationalities and show, for example, that Germans were the largest group in the lower Mid-West, while Scandinavians represented the largest group in the upper Mid-West. Italians tended to cluster in east coast counties and cities like New York, Boston and Rhode Island, while they were almost absent in many counties of Wisconsin and Minnesota. Clustering was strong also within urban areas, where immigrant communities tended to form ethnic enclaves. However, there were differences in location patterns by ethnicity as well as by wave of migration. The early waves of immigrants showed stronger patterns of concentration, forming urban ghettos closely delimited in specific neighbourhoods where they reproduced the life-style of their countries, if not regions, of origin. Subsequent waves tended to be more dispersed. Immigrants from different ethnic groups followed own localization patterns and became more or less dispersed. For example, Germans represented a rather heterogeneous community, divided along religious and regional lines (e.g. catholic and protestant; Bavarian and Prussian). They were also rather diversified in terms of occupations and class structure. All these differences, on top of the large size of the German immigrant population, favoured a more diffused urban distribution, which was not the case for other ethnic communities (Bergquist, 1984).

Fourth, although the vast majority of immigrants were unskilled and of humble origin, a non-negligible part consisted of skilled workers and professionals. Differently from contemporary waves of migration, during the Mass Migration immigrants were both positively and negatively selected (Hatton and Williamson, 1998). Moreover, differences in skills and professional experience were significant across immigrant groups from different countries of origin. German and British tended to be more skilled than natives in specific trades, whereas Italians were usually negatively selected often proceeding from poorer southern Italian regions (Abramitzky and Boustan, 2017). Therefore immigrants contributed to the growing US economy by providing unskilled labour but also relevant skills and know-how for the US industry and agriculture (Sequeira et al., 2020). Immigrants also made a major contribution in terms of scientific and technological discoveries, being overrepresented among inventors and patentees (Khan, 2005; Khan and Sokoloff, 2004; Akcigit

et al., 2017b). This can be explained by the strong incentive given to invention and technological innovation in the US (Khan, 2005). On the one hand, the US patenting system was relatively cheap and affordable compared to European countries, which lowered the entry barriers to independent inventors without a large financial endowment. On the other hand, inventive activity in those days required less physical capital and formal education than today and it was therefore primarily an individual endeavour (Hughes, 2004), where independent inventors played a key role in supplying with high-quality innovation the market for technology, even after the emergence of corporate R&D laboratories in the early 20th century (Nicholas, 2010).

Among immigrant inventors, a variety of profiles and backgrounds can be singled out. A first group includes the foreign born who migrated to the US during their childhood or immediately after. These immigrants learned their trade, built their skills and developed all their professional experience in the US. They include both unskilled workers like John F. O'Connor and remarkable scientists and entrepreneurs like Elihu Thomson. John F. O'Connor arrived in the US from Ireland when he was a child. He was the typical inventor who learned on the job the secrets of his trade and, through trial and error, produced several ameliorations of the railroad gearing (Khan, 2005; McFadyen, 1936). His contribution is notable also because he became one of the greatest patentees of his time. Elihu Thomson's history is well known. Of British origins, he moved to the US at the age of five. Thomson made several contributions in the fields of electricity, power transmission and related fields. Despite he was a reluctant entrepreneur, he was a founder of Thomson-Houston Electric Company, which after merging with Edison General Electric became General Electric.

A second group includes inventors whose formal training or professional experience started in Europe, though their major achievements and contributions (also measured in terms of patents) materialized after migrating to the US. In this group notable and well known examples are Alexander Graham Bell and Nikola Tesla. Their inventions in the fields of electricity, radio transmission and communication revolutionized the understanding of these phenomena and crucially contributed to the development of the emerging electric and telecommunication industries in the US. Our analysis focuses on this second group of inventors: skilled immigrants who arrived in the US as adults with a baggage of relevant work or intellectual experience.

The 1802 naturalization law, which would be in place for over 100 years in the US, allowed any foreigner (i.e. free white male) who had been in residence for five years to be admitted to citizenship. Naturalization was used as an inducement policy to promote more immigration, "to attract immigrants and absorb them into local life" with administrative procedures being "extremely loose and casually administered" for much of the 19th century (Ueda (1992), p. 737).

Immigration, however, raised political opposition over time (Tabellini, 2020). In 1907, to investigate the socio-economic impact of immigrants, the US Congress established an Immigration Commission, which eventually recommended the introduction of restrictions. Starting in 1914 WWI led to an abrupt stop to immigration from Europe, shutting down arrivals from enemy countries such as Germany and the Austro-Hungarian Empire. For instance, with respect to the previous decade, in the 1910s inflows from Germany fell twice as much as those from Great Britain (Tabellini, 2020). Nonetheless, sizeable inflows started over when the conflict ended in 1918. In 1917 the Congress approved a literacy test for all new immigrants arriving in the US. However, this measure did not significantly limit new arrivals. A permanent quota system was then designed in 1921 based on ‘national origin’ and enshrined in the Immigration Acts in 1921 and 1924. The shift to a more restrictive immigration policy was advocated by increasing anti-immigration sentiments, especially against recent immigrant flows from Southern and Eastern Europe (Goldin, 1994). As these flows had gained momentum with the beginning of the XX century, the first Immigration Act approved established that the yearly number of new immigrants from any given country should not exceed 3% of the stock of co-nationals already living in the US according to the 1910 census. In 1924 the second Immigration Act revised the quota to 2% and the reference year for its calculation to 1890, thus imposing stricter restrictions on the inflow of Southern and Eastern Europeans as their immigrant communities were much smaller in 1890 than in 1910. The result was a substantial slowdown in immigrant flows from those parts of Europe. For instance, the flow of Italian immigrants halved, going from above 1 million in the 1910-19 decade to 528,000 in the following decade. Immigrants from Northern Europe, on the other hand, were little affected by the quotas given their large presence in 1890 and the significant slowdown in their arrivals from 1900 onward. The quota system thus introduced a regulatory time discontinuity that is heterogeneous across nationalities. It constrained the inflows from Southern and Eastern Europe while leaving those from North Europe largely unaffected as long as quotas were much less binding for them.

3 Location Choice Model

To guide the ensuing empirical analysis, this section develops a simple model of immigrant inventors’ location choices, in which local co-ethnic networks and ethnic diversity affects both their productivity and their quality of life through localized externalities. In doing so, we build on Ottaviano and Peri (2006) in the wake of Roback (1982), highlighting which variables considered exogenous to the inventors’ location choices will need to be instrumented in the empirical

investigation.

We assume that inventors choose their locations among a large number of counties. Inter-county commuting costs are prohibitive so that inventors' counties of work and residence coincide. We ignore intra-county commuting costs to concentrate on the inter-county distribution of inventors as this is what we observe in the data. Inventors differ in terms of country of origin, which places them in E different ethnic groups ('ethnicities') indexed $e = 1, \dots, E$ including natives.

Focusing on a generic county c , we use L_{ec} to denote the number of inventors who work in that county c . There the different dimensions of multi-ethnicity relevant for ethnic group e are defined by a vector m_{ec} of variables measuring the composition of ethnicities in the local population. The ethnic group's viewpoint, emphasized here as m_{ec} , is meant to capture both the diversity and the co-ethnic network variables we will use in the empirical analysis. These variables are assumed to be exogenous to inventors' location choices and, as such, will need to be instrumented. They affect their production or consumption through external effects that can be positive or negative. To provide a conceptual framework within which to assess the nature and the sign of those effects is the model's purpose.

Inventors' preferences are defined over the consumption of goods G and services S . Goods have no ethnic dimension and are freely traded across counties. Their price is set at the national level and taken as given at the county level. Differently, services are non-tradable and differentiated by ethnicity, which will allow us to determine whether co-ethnic networks mainly work through market or non-market interactions. The utility of an inventor of ethnicity e in county c is given by:

$$U_{ec} = \Lambda(m_{ec}) S_{ec}^{1-\lambda} G_{ec}^{\lambda} \quad (1)$$

with $0 < \lambda < 1$, where S_{ec} and G_{ec} are services and goods consumption respectively, and $\Lambda(m_{ec})$ captures the 'utility effect' of multi-ethnicity m_{ec} . If the first derivative $\Lambda'_e(m_{ec})$ is positive, multi-ethnicity is a local 'consumption amenity'; if negative, it is a local 'consumption disamenity'. We assume that inventors choose the county that offers them the highest indirect utility. Given (1), utility maximization yields:

$$q_{ec} S_{ec} = (1 - \lambda) w_{ec} L_{ec}, \quad p_c G_{ec} = \lambda w_{ec} L_{ec} \quad (2)$$

where q_{ec} and p_c are the prices of local services and goods respectively, while w_{ec} is the inventors'

wage. Substituting (2) in (1) gives an inventor's indirect utility:

$$V_{ec} = (1 - \lambda)^{1-\lambda} \lambda^\lambda \Lambda(m_{ec}) \frac{w_{ec}}{q_{ec}^{1-\lambda} p_c^\lambda}. \quad (3)$$

Goods are supplied by perfectly competitive firms exploiting inventions through a linear technology. Inventions are themselves supplied by perfectly competitive labs employing inventors together with co-ethnic services. Specifically, the number of inventions generated by labs employing inventors of ethnicity f together with their co-ethnic services is determined by the following technology:

$$I_{fc} = \Phi_f(m_{fc}) S_{fc}^{1-\varphi} L_{fc}^\varphi \quad (4)$$

with $0 < \varphi < 1$. In (4) $\Phi_f(m_{fc})$ captures the ‘productivity effect’ associated with multi-ethnicity modelled as a shift in total factor productivity. If the first derivative $\Phi'_f(m_{fc})$ is positive, multi-ethnicity is a local ‘production amenity’; if negative, it is a local ‘production disamenity’. Assuming a one-to-one linear technology and homogenous inventions, the supply of goods associated with innovations by inventors of ethnicity f is $G_{fc} = I_{fc}$ with county-level output $G_c = \sum_{f=1}^E G_{fc}$. As for services, for each ethnic group they are offered by members of the group other than inventors, again through a one-to-one linear technology. Due to the assumption on the technology, the local supply of services of ethnicity f is given by the number N_{fc} of these members, which is assumed to be exogenous to the inventors’ location choices.

Given perfect competition among both firms and labs, profit maximization requires:

$$q_{fc} S_{fc} = (1 - \varphi) p_c G_{fc}, \quad w_{fc} L_{fc} = \varphi p_c G_{fc}, \quad (5)$$

which implies marginal cost pricing so that neither firms nor labs make profits in equilibrium. As goods are freely traded, their price is the same in all counties and we can set $p_c = 1$ by choosing goods as unit of value.

A location equilibrium is defined as a set of prices (q_{ec} , w_{ec} , $c = 1, \dots, C$, $e = 1, \dots, E$) such that in all counties inventors maximize their utilities given their budget constraints, firms and labs maximize profits given their technological constraints, and the markets for inventors, goods and services clear. Moreover, no firm or lab has any incentive to exit or enter. This is granted by

conditions (5), which with $p_c = 1$ jointly imply:

$$q_{ec}^{1-\varphi} w_{ec}^\varphi = (1 - \varphi)^{1-\varphi} \varphi^\varphi \Phi(m_{fc}) \quad (6)$$

Lastly, in equilibrium no inventor has any incentive to change location. This is the case when inventors are indifferent between alternative counties as these offer the same level v_e of indirect utility exogenous to county c :

$$V_{ec} = v_e \quad (7)$$

for all $c = 0, \dots, C$ with V_{ec} determined by (3).

Given $p_c = 1$, conditions (6) and (7) together with (3) determine the equilibrium wage of inventors and the equilibrium price of their co-ethnic services. Then, (5) and (4) can be used to express the equilibrium average productivity of immigrant inventors as a function of the wage obtaining:

$$\frac{I_{ec}}{L_{ec}} = \Theta_{Ie} \Phi(m_{ec})^{\frac{1-\lambda}{1-\lambda\varphi}} \Lambda(m_{ec})^{-\frac{1-\varphi}{1-\lambda\varphi}}, \quad (8)$$

where Θ_{Ie} is a bundling parameter.⁷ Finally, (2) and (5) can be used together with market clearing for co-ethnic services to find the equilibrium number of immigrant inventors:

$$L_{ec} = \Theta_{Le} \Phi(m_{ec})^{\frac{\lambda}{1-\lambda\varphi}} \Lambda(m_{ec})^{\frac{1}{1-\lambda\varphi}} N_{ec}, \quad (9)$$

where Θ_{Le} is another bundling parameter.⁸

Equations (8) and (9) will guide our empirical analysis. They capture the equilibrium relation of the dimension of multi-ethnicity relevant for the location and the productivity of immigrant inventors of a given ethnic group. They must be estimated together in order to empirically assess whether and why multi-ethnicity acts as a pull or push factor. For instance, let's say we observe that L_{ec} increases with m_{ec} so that immigrant inventors of a given nationality are more present where there is more multi-ethnicity. As (9) shows that L_{ec} is an increasing function of $\Lambda(m_{ec})$ and $\Phi(m_{ec})$, their higher presence could be due to a consumption amenity $\Lambda'(m_{ec}) > 0$ but also to a production amenity $\Phi'(m_{ec}) > 0$, which does not allow us to identify the channel through which m_{ec} operates. However, as (8) implies that I_{ec}/L_{ec} increases with $\Phi(m_{ec})$ and decreases with $\Lambda(m_{ec})$, if we also observe that I_{ec}/L_{ec} increases (decreases) with m_{ec} , then it must be that the effect of $\Phi'(m_{ec}) > 0$ ($\Lambda'(m_{ec}) > 0$) dominates. Hence, we can conclude that immigrant inventors' location choices are

⁷Specifically, we have $\Theta_{Ie} \equiv \varphi^{-1} (\theta_\Lambda)^{-\frac{1-\varphi}{1-\lambda\varphi}} (\theta_\Phi)^{\frac{1-\lambda}{1-\lambda\varphi}}$ with $\theta_\Lambda \equiv (1 - \lambda)^{1-\lambda} \lambda^\lambda v_e^{-1}$ and $\theta_\Phi \equiv (1 - \varphi)^{1-\varphi} \varphi^\varphi$.

⁸Specifically, we have $\Theta_{Le} \equiv \varphi (1 - \lambda\varphi)^{-1} (\theta_\Lambda)^{\frac{1}{1-\lambda\varphi}} (\theta_\Phi)^{\frac{\lambda}{1-\lambda\varphi}}$.

driven by a dominant production (consumption) amenity associated with multi-ethnicity. Vice versa, if we observe that L_{ec} decreases and I_{ec}/L_{ec} increases (decreases) with m_{ec} , then immigrant inventors’ location choices are driven by a dominant consumption (production) disamenity.

Moreover, when estimated together, (8) and (9) also allow us to assess whether the co-ethnic network operates mainly through market (N_{ec}) or non-market ($\Lambda(m_{ec})$ and $\Phi(m_{ec})$) interactions. In the former case, a larger (smaller) co-ethnic network is associated with a larger (smaller) number of immigrant inventors by (9), but it is immaterial for their productivity by (8) despite co-ethnic services entering both consumption and production. Therefore, if co-ethnic networks affect immigrant innovators’ productivity, they must operate through non-market interactions.

4 Data Description

Our dataset draws from two sources. For immigrant inventor variables, we exploit an original dataset compiled by [Diodato et al. \(2018\)](#) from the United States Patent and Trademark Office (USPTO) between 1870 and 1940. For county variables, we rely on NHGIS IPUMS decennial Census files between 1870 and 1930.

4.1 Patent Data

The dataset of [Diodato et al. \(2018\)](#) identifies migrant inventors in historical USPTO patent documents through a text-mining algorithm, analogous to the one described in [Petralia et al. \(2016\)](#), and a semi-automated procedure, which extracts detailed information on both country of origin and US county of residence of inventors migrated to the US from 1870 to 1940.

As an illustration, consider the patent record with document number 433,702 reported in Figure 1. This record refers to a patent granted to Nikola Tesla, the great Serbian inventor, and its Tesla Electric Company in August 1890. The patent’s abstract (highlighted) identifies Tesla’s nationality, Austria-Hungary Empire, and his county of residence in the US, New York. These pieces of information are used to classify Tesla as an ‘immigrant inventor’, that is, a patentee from a foreign country e who resides in a US county c .⁹ The automated algorithm identifies patents that

⁹Tesla arrived to the United States in 1884 from Europe after having studied in Graz (Austria) and started working almost immediately at Edison’s premises. He soon left Edison and begun his career as an independent inventor, which brought him fame and recognition, yet did not made him rich. Tesla is considered as one of

can be attributed to an immigrant inventor based on keywords related to nationality. These include ‘subject of’ or ‘citizen of’, which is the patents’ wording usually associated with the description a foreign inventor’s country of origin. Such keywords should appear in combination with words such as ‘residing at’, which indicate where the immigrant inventor is located in the US. This first step leads to the identification of about 20,000 inventors with foreign nationality but living in the US. In a second step, the algorithm has been trained to search for all the patents belonging to the same group of inventors, making it possible to keep track of the patenting activity of inventors arrived as foreign nationals who eventually obtain US citizenship through naturalization. By tracking inventors’ county of residence at the time the patent is granted, the dataset also includes patentees moving across counties in the US. As a final step, a semi-automated procedure is used to double-check all patents identified as granted to immigrants. The end result is a database containing about 43,000 patents granted to about 20,000 immigrants together with their nationality and county of residence as reported in the patent records. With this information we compute the number of immigrant inventors with nationality e located in county c of state s in census year t , which we denote by L_{ecst} . Using corresponding number of patents I_{ecst} , we also compute their average productivity I_{ecst}/L_{ecst} .

Two remarks are in order. First, the dataset identifies immigrant inventors based on foreign nationality rather than foreign birthplace. This is different from census data as we will discuss in the next section. Second, as already discussed in Section 2, at that time naturalization was relatively easy and fast after five years of residence. This entails that patents granted to applicants recorded as foreigner nationals by the USPTO tend to refer to recently arrived foreign-trained immigrants given that US-trained immigrants were likely to be already naturalized before patenting. In this respect, our dataset captures the technology-savvy talents at the top of the immigrant skill distribution.

Figures 2(a) and 2(b) report the number of immigrant inventors active in the US and their patenting activity from 1880 to 1940,. The number of patents granted to foreign nationals steadily increases during the Age of Mass Migration. The outbreak of WWI first and then the introduction of immigration quotas in 1922 and 1924 (highlighted by red lines) is associated with a reduction in the number of immigrant inventors and their patents after 1920.

Table 1 reports descriptive statistics on patenting activity and immigrant inventors by decade and nationalities. It considers 15 nationality groups (consistent with boundary changes across

the greatest immigrant inventor, because of his contribution to AC electricity transmission and to many other technological fields.

Figure 1: Original Patent Document

(No Model.)
N. TESLA.
 ELECTRICAL TRANSFORMER OR INDUCTION DEVICE.
 No. 433,702. Patented Aug. 5, 1890.

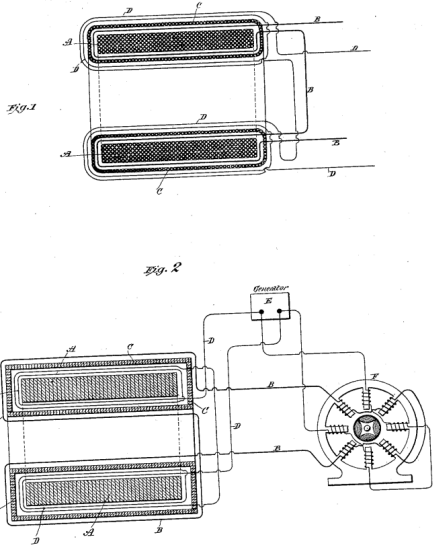

Witnesses:
Raphael Winter
Emiel Sijpeboom

Inventor
Nikola Tesla
 by *Dureau, Curtis & Page*
 Attorneys.

UNITED STATES PATENT OFFICE.

NIKOLA TESLA, OF NEW YORK, N. Y., ASSIGNOR TO THE TESLA ELECTRIC COMPANY, OF SAME PLACE.

ELECTRICAL TRANSFORMER OR INDUCTION DEVICE.

SPECIFICATION forming part of Letters Patent No. 433,702, dated August 5, 1890.
 Application filed March 26, 1890. Serial No. 345,590. (No model.)

To all whom it may concern:
 Be it known that I, **NIKOLA TESLA**, a subject of the Emperor of Austria-Hungary, from Smiljan, Lika, border country of Austria-Hungary, residing at New York, in the county and State of New York, have invented certain new and useful Improvements in Electrical Transformers or Induction Devices, of which the following is a specification, reference being had to the drawings accompanying and forming a part of the same.
 This invention is an improvement in electrical transformers or converters, and has for its main objects the provision of means for securing, first, a phase difference between the primary and secondary currents adapted to the operation of my alternating-current motors and other like purposes, and, second, a constant current for all loads imposed upon the secondary.
 In transformers as constructed now and heretofore it will be found that the electro-motive forces of the secondary very nearly coincides with that of the primary, being, however, of opposite sign. At the same time the currents, both primary and secondary, lag behind their respective electro-motive forces; but as this lag is practically or nearly the same in the case of each it follows that the maximum and minimum of the primary and secondary currents will nearly coincide, but differ in sign or direction, provided the secondary be not loaded or if it contain devices having the property of self-induction. On the other hand, the lag of the primary behind the impressed electro-motive force may be diminished by loading the secondary with a non-inductive or dead resistance—such as incandescent lamps—whereby the time interval between the maximum or the minimum periods of the primary and secondary currents is increased. This time interval, however, is limited, and the results obtained by phase difference in the operation of such devices as my alternating-current motors can only be approximately realized by such means of producing or securing this difference, as above indicated, for it is desirable in such cases that there should exist between the primary and secondary currents, or those which, however

produced, pass through the two circuits of the motor, a difference of phase of ninety degrees; or, in other words, the current in one circuit should be maximum when that in the other circuit is minimum. To more perfectly attain to this condition I obtain or secure an increased retardation of the secondary current in the following manner: Instead of bringing the primary and secondary coils or circuits of a transformer into the closest possible relations, as has hitherto been done, I protect in a measure the secondary from the inductive action or effect of the primary by surrounding either the primary or the secondary with a comparatively-thin magnetic shield or screen. Under these conditions or circumstances, as long as the primary current has a small value, the shield protects the secondary; but as soon as the primary current has reached a certain strength, which is arbitrarily determined, the protecting magnetic shield becomes saturated and the inductive action upon the secondary begins. It results, therefore, that the secondary current begins to flow at a certain fraction of a period later than it would without the interposed shield, and since this retardation may be obtained without necessarily retarding the primary current also, an additional lag is secured, and the time interval between the maximum or minimum periods of the primary and secondary currents is increased. I have further discovered that such a transformer may, by properly proportioning its several elements and determining in a manner well understood the proper relations between the primary and secondary windings, the thickness of the magnetic shield, and other conditions, be constructed to yield a constant current at all loads. No precise rules can be given for the specific construction and proportions for securing the best results, as this is a matter determined by experiment and calculation in particular cases; but the general plan of construction which I have described will be found under all conditions to conduce to the attainment of this result.
 In the accompanying drawings I have illustrated the construction above set forth.
 Figure 1 is a cross-section of a transformer embodying my improvement. Fig. 2 is a simi-

The figure reports an example of a historical patent document of the United States Patent and Trademark Office (USPTO), with highlighted the information codified by the text analysis.

countries of origin occurred during the period) with totals reported in the last column. It shows that inventors from Great Britain and Ireland outperform all other nationalities with more than 18,000 patents. They are followed by Scandinavians and Germans (over 7,000 patents), Eastern Europeans (about 4,500 patents) and Austro-Hungarians (about 3,500 patents).

Figure 3 depicts the distribution of immigrant inventors' average productivity (i.e. number of patents per inventor). It shows that in the period under consideration about one third of immigrant inventors are granted only one patent and the vast majority of them are granted less than ten over their career.

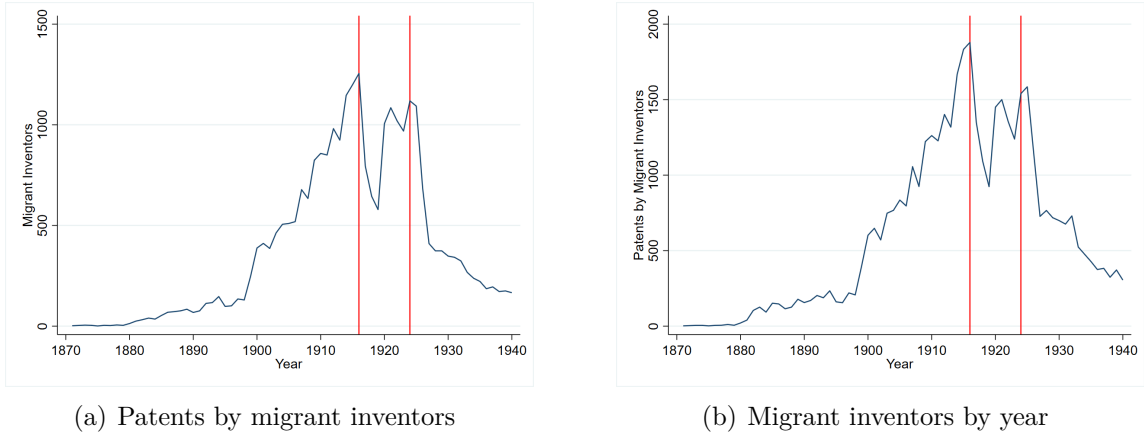

Figure 2: Patents by and number of migrant inventor. 1880-1930

Table 1: Patents and number of migrant inventors in US by nationality. 1880-1930

Nationality	1880-90		1890-00		1900-1910		1910-1920		1920-30		1930-1940		1880-1940	
	Pat.	Inv.	Pat.	Inv.	Pat.	Inv.	Pat.	Inv.	Pat.	Inv.	Pat.	Inv.	Pat.	Inv.
Australia & New Zealand	0	0	1	1	6	4	9	8	18	11	16	3	52	28
Austro-Hungarian Emp.	25	3	91	41	396	257	1362	895	1017	532	285	99	3239	1854
Benelux	8	5	19	9	133	71	184	98	86	47	29	6	461	238
Canada	26	19	108	54	404	214	539	254	572	242	229	76	1908	872
Scandinavia	65	46	342	203	1597	737	2308	1137	1479	678	699	179	6617	3038
Eastern Europe	16	8	62	45	393	269	1377	811	1528	898	502	143	3996	2214
France	26	11	56	29	278	130	280	142	256	117	85	22	992	457
Germany	124	60	306	171	1325	698	2063	924	1014	430	316	108	5202	2415
Great Britain & Ireland	874	311	1419	697	3535	1718	4430	2017	3795	1345	1871	416	16263	6647
Greece	0	0	3	2	25	14	77	59	118	94	15	9	240	179
Italy	9	6	51	25	289	195	742	509	750	427	312	66	2193	1242
Asia	0	0	7	5	57	37	284	184	245	144	21	14	618	387
Portugal	0	0	0	0	3	3	13	9	26	22	1	1	43	35
Spain	5	5	9	5	39	19	54	35	86	48	5	5	198	117
Switzerland	47	17	45	26	277	142	385	183	286	128	205	40	1318	546
Total	1225	491	2519	1313	8757	4508	14107	7265	11276	5163	4591	1187	43340	20269

Figure 4 presents a map of the distribution of immigrant inventors across US counties between 1880 and 1940, standardized by the county’s population in 1930. Figure 5 depicts the parallel distribution of immigrant inventors’ patents.

4.2 Census Data

We match our historical patent data on immigrant inventors with US Census data between 1870 and 1930.¹⁰ In particular, we employ NHGIS IPUMS county-level decennial census files (Manson

¹⁰As it will be discussed in Section 5, we will investigate the impact of county variables observed at census frequency on immigrant inventors’ outcomes in the subsequent decades. Accordingly, the last census year we

Figure 3: Number of patents per inventor. 1880-1940

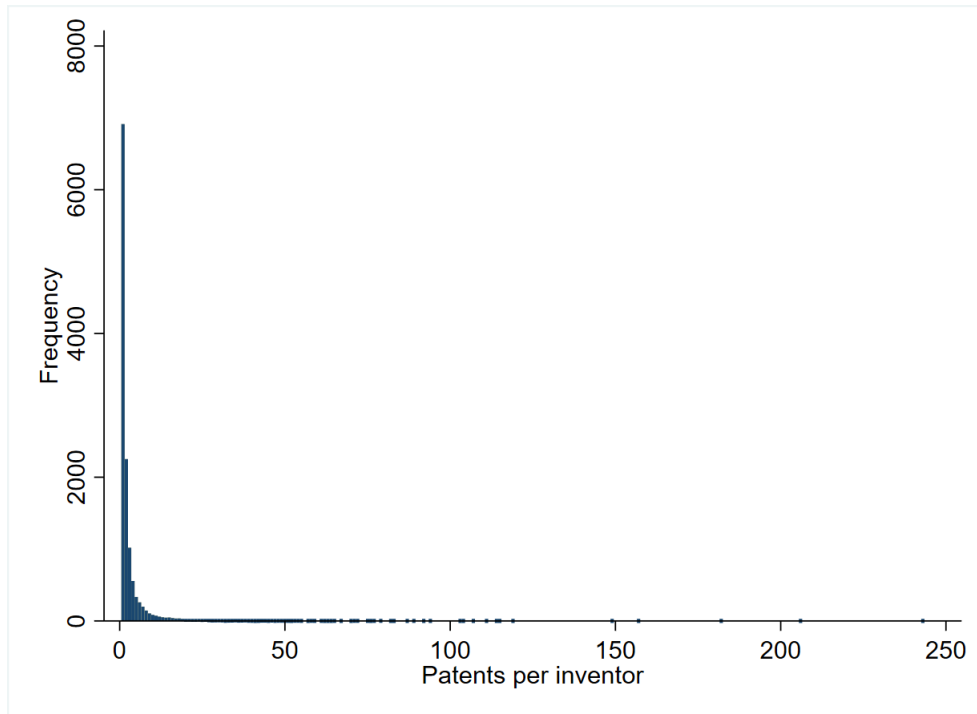
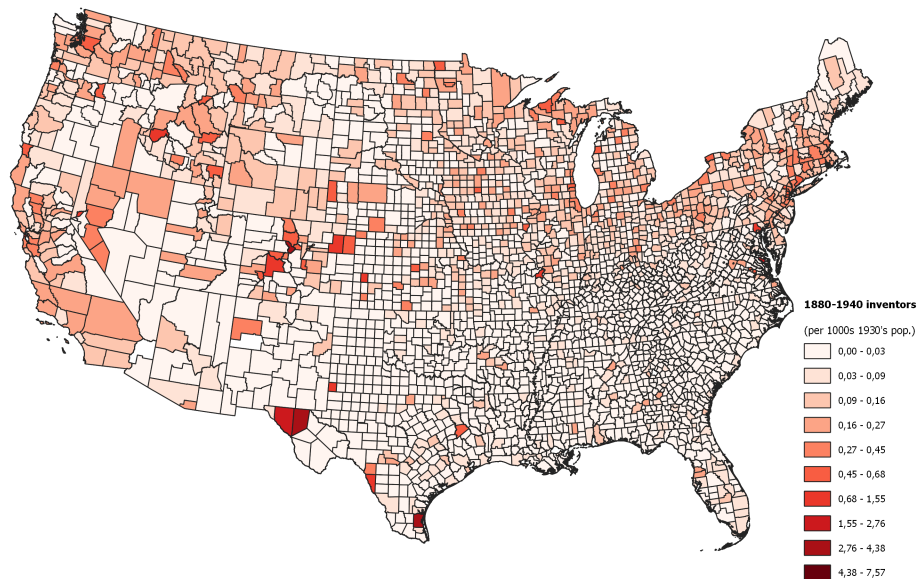
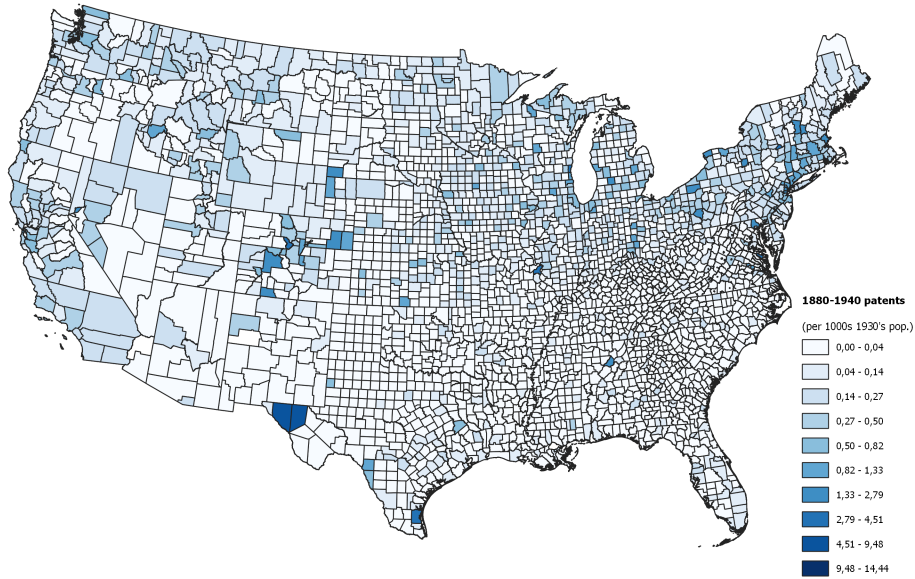

Figure 4: Migrant inventors by county (on 1000s 1930's pop.). 1880-1940



consider is 1930, that is, the one related to the last decade covered by our patent data 1930-1940.

Figure 5: Migrant inventors’ patents by county (on 1000s 1930’s pop.). 1880-1940



et al., 2019) to construct measures of the different dimensions of our model’s local multi-ethnicity m_{ec} .¹¹ We consider county boundaries in 1990¹² and focus on counties where in each census year there are at least 2,500 residents (which is the IPUMS threshold used to distinguish urban from rural counties) and at least immigrant resident. This gives a balanced panel of about 2,900 counties for the years 1870–1930. Differently from USPTO data on immigrant inventors, here immigrant status is identified based on foreign birthplace rather than foreign nationality. Accordingly, the co-ethnic network of immigrant inventors with ethnicity e consists of all immigrants born in the foreign country the immigrant inventors are nationals of when they are granted their first US patent.

The key variable we recover from the IPUMS files is the number of members of ethnic group e located in county c of state s in census year t , which we denote by N_{ecst} . Then, assigning natives to group $e = 1$, we calculate the local population as $P_{cst} = \sum_e N_{ecst}$ and the total number of local immigrants as $M_{cst} = \sum_{e \neq 1} N_{ecst}$. Finally, we compute the share of group e ’s immigrants in the local population as $s_{ecst} = N_{ecst}/P_{cst}$; the share of immigrants from all other groups as $s_{-ecst} = (M_{-ecst} - N_{ecst})/P_{cst}$, where M_{-ecst} is the stock of immigrants of all ethnicities except e ; and the dispersion within immigrant population across ethnic groups other than e by the Theil

¹¹These files are available at: <https://data2.nhgis.org/main>.

¹²We adopt the crosswalk, developed by Eckert et al. (2018), between 1990’s and historical counties’ boundaries.

index:

$$Theil_{-ecst} = \sum_{i \neq e} \frac{N_{icst}}{M_{-ecst}} \ln\left(\frac{M_{-ecst}}{N_{icst}}\right). \quad (10)$$

We use s_{ecst} to capture group e 's co-ethnic network, s_{-ecst} to capture the ‘between’ diversity of local multi-ethnicity from the group’s viewpoint, and $Theil_{-ecst}$ to capture its ‘within’ diversity.¹³

Table 2 reports the shares of ethnic groups in the US population between 1870 and 1930. In the last two rows it also reports the overall immigration share and the Theil index for immigrants only. The overall immigration share peaks in 1910 (15.48%) with a sharp decline after WWI and the introduction of immigration quotas in 1920s. Although immigrants from Great Britain and Ireland, Germany and Scandinavia account for most of the immigrant population at the beginning of the Age of Mass Migration, the table shows that their shares start to decline at the end of 19th century when a sizeable number of immigrants start to arrive from Southern Europe (especially Italy), Eastern Europe and the Austro-Hungarian Empire. This leads to a substantial increase in the diversity of the immigrant population with the Theil index increasing from 1.4 in 1870 to 2.19 in 1920.

Figures 6 and 7 display the cross-county distribution of the average overall immigration share and the average the Theil index in the period 1880-1930.

5 Empirical Strategy

In operationalizing (8) and (9) we exploit variation in co-ethnic networks and diversity across our 2,900 counties and 15 ethnicities over time. In particular, we look at the impacts of local co-ethnic networks and diversity in each census year on the change in immigrant inventors’ presence and productivity in the subsequent decade. This implies that the last census year we consider for the explanatory variables is 1930 and the last decade we consider for the outcome variables is 1930-1940.

¹³The Theil index aggregates ethnic groups’ shares using a logarithmic weight that decreases with the shares. This implies a decreasing marginal contribution to diversity of each group’s relative size. Most studies in the literature use the fractionalization index (i.e. the complement to one of the Herfindal index) as a measure of local ethnic diversity (see, e.g., Alesina et al. (2016); Docquier et al. (2018)). When we use this alternative index instead of the Theil index, our empirical analysis delivers similar results (available upon request).

Table 2: Immigration shares (%) and within diversity in US Census data 1870-1930

Birthplace	1870	1880	1890	1900	1910	1920	1930
Australia & New Zealand	0.00	0.00	0.01	0.00	0.00	0.00	0.00
Austro-Hungarian Emp.	0.14	0.14	0.48	0.76	1.81	1.41	1.10
Benelux	0.11	0.05	0.17	0.17	0.17	0.17	0.15
Canada	1.28	1.44	1.57	1.55	2.56	1.99	2.06
Scandinavia	0.61	0.83	1.49	1.48	1.49	1.24	1.04
Eastern Europe	0.02	0.07	0.52	1.07	1.80	2.64	2.28
France	0.30	0.21	0.18	0.13	0.13	0.14	0.11
Germany	4.40	3.95	4.45	3.50	2.70	1.59	1.32
Great Britain & Ireland	6.83	5.56	4.99	3.66	2.78	2.04	1.76
Greece	0.00	0.00	0.00	0.01	0.11	0.17	0.13
Italy	0.02	0.05	0.29	0.64	1.45	1.52	1.47
Asia	0.16	0.20	0.17	0.26	0.00	0.00	0.00
Portugal	0.00	0.00	0.02	0.05	0.07	0.07	0.05
Spain	0.00	0.00	0.01	0.00	0.02	0.04	0.04
Switzerland	0.20	0.10	0.16	0.15	0.13	0.11	0.09
Rest Of America	0.10	0.14	0.16	0.17	0.26	0.48	0.06
All migrants	14.18	12.74	14.68	13.60	15.48	13.62	11.68
Within migrants diversity (Theil)	1.40	1.49	1.78	2.00	2.13	2.19	2.12

Figure 6: Immigration share by county (1880-1930 average)

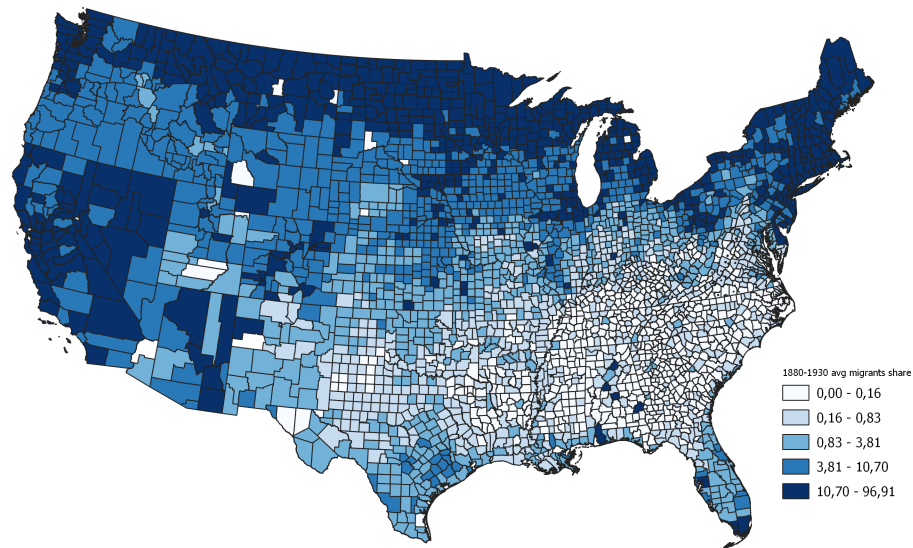
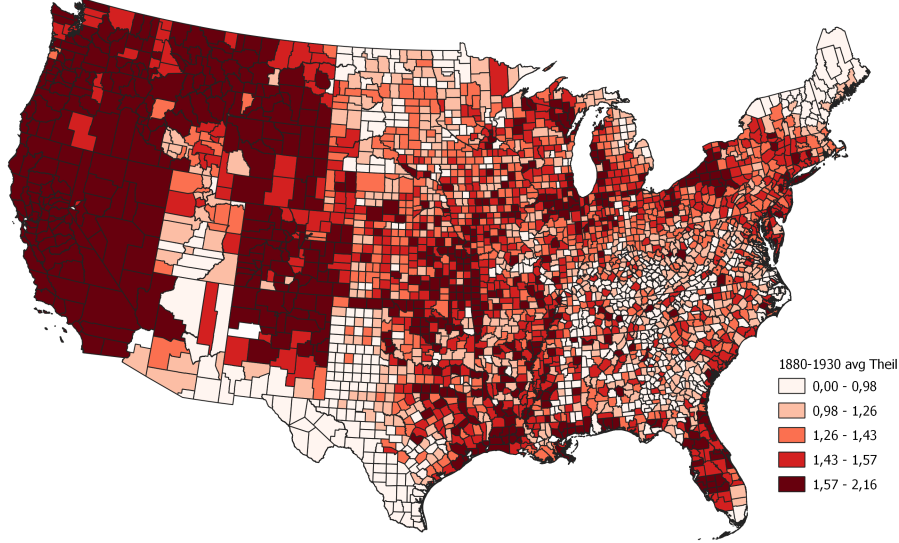

Figure 7: Within-migrants diversity–Theil Index (1880-1930 average)



Our specification is the following:

$$\ln(O_{ecst}) = \alpha_0^O + \beta_1^O s_{ecst} + \beta_2^O s_{-ecst} + \beta_3^O Theil_{-ecst} + \delta_{st}^O + \mu_{ec}^O + t\pi_{ec}^O + \epsilon_{ecst}^O \quad (11)$$

where s_{ecst} , s_{-ecst} and $Theil_{-ecst}$ respectively measure group e 's co-ethnic network, between and within diversity as described in Section 4.2. As required by the model described in Section 3, we estimate (11) in parallel using as outcome variable O_{ecst} either the number of group e 's inventors L_{ecst} (in light of (9)) or their average patenting productivity $T_{ecst} = I_{ecst}/L_{ecst}$ (in light of (8)). We control for unobserved heterogeneity by including ethnicity-by-county fixed effects μ_{ec} , which absorb all time-invariant characteristics for ethnic group e in county c , so that identification comes from decennial variations within ethnicity-county cells. Moreover, we introduce state-by-year fixed effects δ_{st} to adjust for state-specific time-varying shocks and ethnicity-by-county time-linear trends $t\pi_{ec}$ to account for any cell-specific linear trajectories over time. Finally, ϵ_{ecst} is an idiosyncratic component. Standard errors are clustered at the level of the unit of analysis as to consider the correlation over time within ethnicity-county cells.

The main coefficients of interest are β_1^O , β_2^O and β_3^O for $O \in \{L, T\}$ corresponding to variables

s_{ecst} , s_{-ecst} and $Theil_{-ecst}$ respectively. According to our model, as discussed in Section 3, if the estimated coefficients on a given variable were positive (negative) in both regressions (11) for $O \in \{L, T\}$, then that variables would act as a pull (push) factor through a dominant production amenity (disamenity). Differently, if the estimated coefficient were positive (negative) for $O = L$ and negative (positive) for the $O = T$, then the variable would act as pull (push) factor through a dominant consumption amenity (disamenity). Finally, a positive estimate for β_1^L and a zero estimate for β_1^T would reveal that co-ethnic networks act as a pull factor through market rather than non-market interactions.

All explanatory variables are standardized so that their coefficients can be interpreted as average impacts of a standard deviation change on the dependent variable. This transformation ease the comparison of the magnitudes of the estimated coefficient of explanatory variables with different scales. This is particularly important in our analysis if we want to compare the effects of between-diversity (measured by the local share of immigrants ranging between 0 and 1) and within diversity (measured by the Theil index ranging between 0 and the logarithm of 14, i.e. the number of ethnic groups).

5.1 Identification

It is well recognized that immigrants are not randomly assigned across localities but self-select into specific locations according to individual and regional characteristics (Card, 2001). Therefore, OLS estimation of (11) could be biased if unobserved (county or ethnicity) time-varying factors simultaneously affected immigration, ethnic composition and immigrant inventions. On the one hand, technological shocks to local productivity may attract or repel both immigrants and natives, but may disproportionately affect the location choices of the former if these are more mobile than the latter (Kerr et al., 2016). This confounding factor would generate an upward bias in the estimated correlation between diversity and inventors' outcomes (Ottaviano and Peri, 2005, 2006; Ager and Brückner, 2013). On the other hand, it has been argued that low-skilled immigration in the US changed the scale of production by stimulating labor complementary inventions (Acemoglu, 2010; Doran and Yoon, 2018). Conversely, innovations may have fostered labor-saving technological change, hence reducing diversity through the displacement of low-skilled immigrants. This reverse causality channel would generate a downward bias in the estimated relation between diversity and inventors' outcomes. However, the presence of immigrant inventors may also promote local productivity and growth (Kerr et al., 2016). In this case, their location choices would affect

the location choices of other immigrants by stimulating the local economy (Abramitzky et al., 2019; Romer, 1990; Zucker et al., 1998; Jaffe et al., 2001; Kerr and Lincoln, 2010; Hunt, 2011). This additional channel of reverse causality would then lead to an upward bias in the estimated correlation between diversity and inventors’ outcomes.

We address these issues following two different 2SLS approaches. First, we construct a set of shift-share instrumental variables for each endogenous variable in our model following the widely used methodology based on pre-existing immigrant settlements (Card, 2001). Second, we exploit the quasi-experimental variation provided by the breakout of WWI and the introduction of immigration quotas in the early 1920s, which restricted the number of new immigrants based on their country of origin as discussed in Section 2 (King, 2009; Ager and Hansen, 2017; Tabellini, 2020).

5.1.1 Shift-Share Approach

The shift-share approach developed by (Card, 2001) - and then extensively used in the immigration literature - exploits the tendency of new immigrants to choose areas where previous immigrants of the same origin have settled in order to benefit from local co-ethnic networks. We rely on this logic to construct instruments for our key variables s_{ecst} , s_{-ecst} and $Theil_{-ecst}$. As explained in Section 4.2, their building blocks are the numbers of members of the different ethnic groups e located in county c of state s in census year t , which we denoted by N_{ecst} .

Specifically, we take 1870 as reference year and, similarly to Docquier et al. (2018), we define the predicted change in the stock of members of ethnic group e (native group included) in county c between census years $t - 1$ and t as:

$$\Delta \widehat{N}_{ecst} = s_{ecs,1870}^{US} \times \Delta N_{e,-s,[t-1;t]} \quad t = 1880, \dots, 1930 \quad (12)$$

where the aggregate ‘shift’ component $\Delta N_{e,-s,[t-1;t]}$ is the change in the number of immigrants from group e arrived between $t - 1$ and t in the whole US excluding state s where county c is located. Then (12) apportions the aggregate shift component across counties according to their shares $s_{ecs,1870}^{US}$ of the total number of group members who were already in the US in 1870. Next, we compute the predicted stock of immigrants from e in county c for census year t as their stock in 1870 plus the cumulated sum of the predicted changes until t :

$$\widehat{N}_{ecst} = N_{ecs,1870} + \sum_{\tau \leq t} \Delta \widehat{N}_{ecst\tau} \quad t = 1880, \dots, 1930. \quad (13)$$

Finally, we compute the shift-share predicted measures of group e 's co-ethnic network, between and within diversity replacing \widehat{N}_{ecst} in the definitions of s_{ecst} , s_{-ecst} and $Theil_{-ecst}$ respectively.

5.1.2 Quasi-Experimental Approach

The shift-share approach has been criticized because the exclusion restriction may be hard to defend as the instruments are weighted averages of many different shifts (Goldsmith-Pinkham et al., 2018) and tend to be strongly serially correlated whenever the ethnic mix of immigrant flows is similar over time (Jaeger et al., 2018). We therefore supplement the shift-share analysis with an alternative approach that leverages the exogenous variation in migrant inflows generated by the two events that, as discussed in Section 2, put an end to the Age of Mass Migration: WWI and quotas. In doing so, we follow Ager and Hansen (2017) and Tabellini (2020). Ager and Brückner (2013) allocate the negative immigration shock ('missing migrants') induced by the quotas at national level across local labor markets according to their shares of quota-affected nationalities in 1920 just before restrictions were introduced. While specifying a similar city-level measure of quota exposure, Tabellini (2020) also exploits the outbreak of WWI to construct an analogous measure of 'missing migrants' based on the 1910 geographic distribution of immigrants born in countries that were not part of the Allies during the conflict.

Combining the two approaches we first construct the following ethnicity-by-county measure of 'WWI exposure' during the 1910s as in Tabellini (2020):

$$WWI.exp.ecs,1920 = s_{ecs,1910}^{US} \times Enemy_e \times Imm_{e,00-10} \quad (14)$$

where $Enemy_e$ is a dummy equal to 1 for enemy countries (Germany and the Austro-Hungarian Empire), $Imm_{e,00-10}$ is the average yearly migration inflow from country e to the US from 1900 to 1910, and $s_{ecs,1910}^{US}$ is county c 's share of the total number of ethnic group e 's members already in the US in 1910.¹⁴ Though WWI curbed immigration from all origins, arrivals from enemy countries were completely shut down. Hence, (14) tells that counties with a higher share $s_{ecs,1910}^{US}$ of enemy immigrants in 1910 were more exposed to the negative aggregate WWI immigration shock $Enemy_e \times Imm_{e,00-10}$.

¹⁴ $Imm_{e,00-10}$ is built by using the micro-data from 1920 IPUMS Full Count Census file, which reports the migrant's year of arrival to US. We collapse this information at national level to obtain estimates of yearly inflows by migrants' birthplace from 1900 to 1914. $Imm_{e,00-10}$ in (14) takes the simple average over the period 1900-1910, whereas $Imm_{e,00-14}$ in (15) takes the simple average over the period 1900-1914.

We then define an ethnicity-by-county measure of ‘quota exposure’ during the 1920s as in [Ager and Hansen \(2017\)](#):

$$Q.exp.ecs,1930 = s_{ecs,1920}^{US} \times \max\left(\frac{Imm_{e,00-14} - Q_e}{Imm_{e,00-14}}, 0\right) \quad (15)$$

where $s_{ecs,1920}^{US}$ is county c ’s share of the total number of ethnic group e ’s members already in the US in 1920, $Imm_{e,00-14}$ is the yearly migration inflow from country e to the US from 1900 to 1914, Q_e is the number of immigrants from country e allowed to enter the US by the corresponding quota between 1922 and 1930 as per Census Statistical Abstract 1931. The ratio in (15) measures the quota exposure for foreign-group e in the US as a whole and ranges between 0 and 1. It equals 0 when the quota for country e is higher than the actual average yearly inflow between 1900 and 1914. It equals 1 in the extreme case in which immigration from country e is totally banned. It takes values between 0 and 1 when the quota is lower than the actual average yearly inflow.

Table 3 reports the quota exposure and its components by ethnicity. For illustrative purposes, it is useful to consider the quota exposure for Italian and German immigrants. The former experienced large inflows from 1900 to 1914 with about 78,000 average yearly arrivals, but the average yearly quota introduced in the early 1920s allowed less than 17,000 new arrivals per year from 1922 to 1930. As a result, the quota for Italians was binding and their quota exposure is very high (0.8). Conversely, from 1900 to 1914 German inflows were much smaller with only about 24,000 average yearly arrivals. The corresponding quota of about 54,000 new arrivals for 1922-1930 was not binding so that Germans’ quota exposure is nil (0).

The rationale for using $WWI.exp.ecs,1920$ and $Q.exp.ecs,1930$ to build instruments for s_{ecst} , s_{-ecst} and $Theil_{-ecst}$ is that counties with higher shares of WWI- or quota-affected ethnic groups are expected to experience lower growth in the stocks of immigrants from those ethnic groups. We proceed as follows. We first run a stage-zero regression of the change in the stock of immigrants from e to c on $WWI.exp.ecs,1920$ and $Q.exp.ecst$:

$$\Delta N_{ecst} = a_0 + a_1 1920 \times WWI.exp.ecs,1920 + a_2 1930 \times Q.exp.ecs,1930 + \delta_{st} + \mu_{ec} + \epsilon_{ecst} \quad (16)$$

where ΔN_{ecst} is the change in the stock of ethnic group e in c between $t - 1$ and t . Exposure measures $WWI.exp.ecs,1920$ and $Q.exp.ecst$ are interacted with a year dummy in order to check whether they are significant predictors in the affected years only. We include ethnicity-by-county and state-by-year fixed effects (μ_{ec} and δ_{st}). The estimated coefficients from (16) allows us to predict WWI and quota induced changes over time in the immigrant stocks across ethnicity-by-

Table 3: Quota exposure by foreign nationality

Birthplace	Avg yearly inflow 1900-1914	Avg yearly Quota 1922-1930	Quota exp. 1922-1930
Australia & New Zealand	454.46	536.89	0
Austro-Hungarian Emp.	75026.13	14571	0.80
Benelux	6545.67	3418.55	0.48
Canada	26253.2	Unrestricted	0
Scandinavia	34955.53	25470.89	0.27
Eastern Europe	139382.7	29761.55	0.79
France	4092.87	4449.22	0
Germany	23976.4	54086.45	0
Great Britain & Ireland	52498	69830	0
Greece	8186.07	1162	0.86
Italy	78036.87	16823.45	0.78
Asia	9242.93	2021.67	0.78
Portugal	3882	1156.111	0.70
Spain	1718	404.78	0.76
Switzerland	2536.87	2596.4	0

county cells as:

$$\begin{aligned}\Delta WWI - \widehat{N}_{ecs1920} &= \hat{a}_1 WWI.exp_{ecs,1920}, \\ \Delta Q - \widehat{N}_{ecs1930} &= \hat{a}_2 Q.exp_{ecs,1930}.\end{aligned}$$

We then obtain the predicted post-WWI and post-quota stocks by adding these predicted changes to the stocks in 1910 and 1920 respectively:

$$\begin{aligned}WWI - \widehat{N}_{ecs1920} &= N_{ecs1910} + \Delta WWI - \widehat{N}_{ecs1920}, \\ Q - \widehat{N}_{ecs1930} &= N_{ecs1920} + \Delta Q - \widehat{N}_{ecs1930}.\end{aligned}$$

Finally, we compute the WWI and quota predicted measures of group e 's co-ethnic network, between and within diversity by replacing $WWI - \widehat{N}_{ecs1920}$ and $Q - \widehat{N}_{ecs1930}$ in the definitions of s_{ecst} , s_{-ecst} and $Theil_{-ecst}$ while using the shift-share prediction \widehat{N}_{ecst} for natives ($e = 1$).

6 Results

In this section we present results from OLS and 2SLS estimation based on the IVs describe in Section 5.1. Table 4 presents first stage estimates. Columns 1 to 3 refer to the shift-share in-

struments showing that they strongly predict the corresponding endogenous variables. The values for the Weak Instrument tests for multiple endogenous variables by Sanderson and Windmeijer (2016) are above the 10-threshold for a robust first stage (Stock and Yogo, 2002). Columns 4 to 7 display both stage-zero and first-stage regression results for the WWI- and quota-based IVs. The stage-zero estimates in Column 4 shows that, consistently with Ager and Hansen (2017) and Tabellini (2020), the ethnicity-by-county measures of WWI and quota exposure have significant negative effects on the change in the local immigrant stocks in the post-WWI and quota decades. On the one hand, during the 1920s (see the interaction with the 1930 time dummy), more quota-exposed ethnicity-county cells exhibit significantly smaller changes in immigrant stocks than less exposed cells. On average, a percentage point increase in quota exposure reduces the change in the stock of immigrants by 2,706 units between 1920 and 1930. On the other hand, a ‘missing migrant’ predicted by the WWI-exposure variable corresponds to a reduction of 1.16 actual immigrants between 1910 and 1920. The variations induced by WWI and the quotas provide a strong enough prediction for the first difference in all the endogenous variables. First-stage estimates in Columns 5 to 7 highlight that also these IVs are positively and significantly associated with the correspondent endogenous variables, and the Sanderson and Windmeijer (2016) Weak Instrument tests return again values above the 10-threshold for robust first stage regressions.

Tables 5 and 6 compare the second stage results for the two sets of IVs with the corresponding OLS estimates based on specification (11). In table 5 the outcome variable is the (log) stock of immigrant inventors L_{ecst} from ethnic group e who are granted a patent while living in county c between t and $t + 1$. Columns 1 and 2 OLS report estimates with and without cell-specific linear time trends. Using the same specifications, Columns 3 and 4 show 2SLS results with shift-share IVs, while Columns 5 and 6 refer to 2SLS results relying on WWI and quota IVs. Both OLS and 2SLS results highlight a positive and significant impact of co-ethnic networks on immigrant inventors location choices. They also yield positive and significant impact of both between and within diversity on immigrant inventors’ location choices. Hence, both co-ethnic networks and diversity appear to act as pull factors. Specifically, after adjusting for linear time trends, a standard deviation increase in the within-diversity Theil Index ($= 0.399$) is associated with a rise in the stock of immigrant inventors by 18.3% in the case of shift-share IVs and 10.8% in the case of WWI and quota IVs.¹⁵ At the sample mean ($= 0.11$ immigrant inventors per ethnicity-by-county cell), the former effect equals 0.01, while the latter equals 0.02 additional inventors per cell. As for between diversity, after adjusting for cell-specific linear time trends, the shift-share results in Column 4 reveal that a standard deviation increase in the population share of immigrants other than e ($= 0.95\%$) is

¹⁵Percentage changes are computed as $(e^{\hat{\beta}} - 1)\%$ where $\hat{\beta}$ refers to the relevant coefficient estimate.

Table 4: First Stage Results: shift-share, quota and WWI instruments

Exp. Var.	Shift-share IV			Quota and WWI IVs			
	1st stage regressions			Stage-zero	1st stage regressions		
	(1)	(2)	(3)	(4)	(5)	(6)	(7)
	s_{ecst}	$Theil_{ecst}$	s_{-ecst}	ΔN_{ecst}	Δs_{ecst}	$\Delta Theil_{ecst}$	Δs_{-ecst}
\widehat{s}_{ecst}	0.3455*** (0.0280)	-0.0507*** (0.0069)	-0.0207*** (0.0055)				
\widehat{Theil}_{ecst}	0.0052 (0.0057)	0.0951*** (0.0105)	0.0304*** (0.0056)				
\widehat{s}_{-ecst}	-0.0538*** (0.0105)	-0.4357*** (0.0232)	0.3077*** (0.0188)				
$1920 \times WWI.exp_{ecs,1920}$				-1.1664*** (0.3214)			
$1930 \times Q.exp_{ecs,1930}$				-270614.4764** (126,261.5294)			
$1920 \times WWI-\Delta\widehat{s}_{ecs1920}$					0.0743*** (0.0082)	0.0083*** (0.0022)	0.0275*** (0.0031)
$1930 \times Q-\Delta\widehat{s}_{ecs1930}$					0.0633*** (0.0111)	0.0076*** (0.0014)	0.0290*** (0.0037)
$1920 \times WWI-\Delta\widehat{Theil}_{ecs1920}$					0.0033 (0.0022)	0.0353*** (0.0036)	0.0138*** (0.0016)
$1930 \times Q-\Delta\widehat{Theil}_{ecs1930}$					0.0088*** (0.0026)	0.0614*** (0.0039)	-0.0154*** (0.0036)
$1920 \times WWI-\Delta\widehat{s}_{-ecs1920}$					0.0205*** (0.0039)	0.0151*** (0.0029)	0.1101*** (0.0033)
$1930 \times Q-\Delta\widehat{s}_{-ecs1930}$					0.0205*** (0.0037)	0.0270*** (0.0021)	0.1094*** (0.0065)
Observations	171,990	171,990	171,990	171,780	171,780	171,780	171,780
Ethnicity by County FE	Yes	Yes	Yes	Yes	Yes	Yes	Yes
Year by State FE	Yes	Yes	Yes	Yes	Yes	Yes	Yes
Ethn. by County time-linear trends	Yes	Yes	Yes				
First differences model				Yes	Yes	Yes	Yes
S-W Weak identification test	205.6	170.3	140.5		30.20	100.7	252.2

Standard errors clustered at ethnicity-by-county level in parentheses (*** p<0.01, ** p<0.05, * p<0.1)

associated with a 63% increase in the immigrant inventor stock, which represents a 0.069 deviation from the sample mean. The estimated effect is 8.3% in the case WWI and quota IVs in Column 6. OLS point estimates, although positive and significant, are always significantly lower than the 2SLS ones for all three explanatory variables. Based on the discussion at the beginning of Section 5.1, this downward bias may be due to omitted variables that push co-ethnic networks as well as diversity on the one side and inventors on the other side in opposite directions, as well as by reverse causation, as long as inventions may have fostered labor-saving technological change, hence reducing co-ethnic networks and diversity through the displacement of low-skilled immigrants.

Albeit suggesting that co-ethnic networks and diversity attract immigrant inventors, these results, as discussed in Section 5, are not enough to assess whether immigrant inventors are attracted by

production or consumption considerations. This is why in Table 6 we re-estimate specification (11) with immigrant inventors' productivity $T_{ecst} = I_{ecst}/L_{ecst}$ as outcome variable. We find positive effects of both between and within diversity on immigrant inventors' patenting productivity together with a positive co-ethnic network effect. After adjusting for linear time trends, the shift-share results in Column 4 imply that a standard deviation increase in within diversity leads to a 8% rise in immigrants inventors' productivity, while the effect of a standard deviation increase in between diversity leads to a rise in their productivity by about 25%. With a sample mean of 0.06 patents per immigrant inventor by cell, those effects respectively imply about 0.005 and 0.015 additional patents per inventors. As for co-ethnic networks, a standard deviation increase in within diversity leads to a 11% rise in immigrants inventors' productivity, corresponding to 0.007 additional patents per inventor. The 2SLS regressions with the WWI and quota instruments yield similar point estimates in the case of within diversity, while the impacts on immigrant inventors' productivity is substantially smaller for between diversity and co-ethnic networks.

To summarize, the positive and significant coefficient estimates in both Tables 5 and 6 reveal that co-ethnic networks as well as between and within diversity acts a pull factors on immigrants inventors and this happens through a dominant production amenity channel.

Table 5: Diversity and migrant inventors' location choice. OLS and 2SLS estimates

	OLS		Shift-Share IV		Quota and WWI IVs	
	(1) $\log(L)_{ecst}$	(2) $\log(L)_{ecst}$	(3) $\log(L)_{ecst}$	(4) $\log(L)_{ecst}$	(5) $\Delta\log(L)_{ecst}$	(6) $\Delta\log(L)_{ecst}$
Within Diversity: $Theil_{ecst}$	0.0074*** (0.0008)	0.0106*** (0.0011)	0.0114** (0.0056)	0.1682*** (0.0284)	0.1703*** (0.0350)	0.1025*** (0.0133)
Between Diversity: s_{ecst}	0.0113*** (0.0021)	0.0498*** (0.0050)	0.1053*** (0.0209)	0.4893*** (0.0612)	0.0421*** (0.0100)	0.0836*** (0.0095)
Network: s_{ecst}	0.0194*** (0.0029)	0.0618*** (0.0075)	0.0450*** (0.0090)	0.1737*** (0.0213)	0.0905*** (0.0273)	0.0824*** (0.0184)
Observations	171,990	171,990	171,990	171,990	171,780	171,780
R-squared	0.6482	0.7195				
Ethnicity by County FE	Yes	Yes	Yes	Yes		Yes
Year by State FE	Yes	Yes	Yes	Yes	Yes	Yes
Ethn. by County time-linear trends		Yes		Yes		
First differences model					Yes	Yes

Standard errors clustered at ethnicity-by-county level in parentheses (*** p<0.01, ** p<0.05, * p<0.1)

Table 6: Diversity and migrant inventors' productivity. OLS and 2SLS estimates

	OLS		Shift-Share IV		Quota and WWI IVs	
	(1) $\log(T)_{ecst}$	(2) $\log(T)_{ecst}$	(3) $\log(T)_{ecst}$	(4) $\log(T)_{ecst}$	(5) $\Delta\log(T)_{ecst}$	(6) $\Delta\log(T)_{ecst}$
Within Diversity: $Theil_{ecst}$	0.0056*** (0.0008)	0.0063*** (0.0009)	0.0012 (0.0061)	0.0761*** (0.0221)	0.1054*** (0.0315)	0.0635*** (0.0124)
Between Diversity: s_{ecst}	0.0063*** (0.0020)	0.0256*** (0.0036)	0.0150 (0.0174)	0.2228*** (0.0417)	0.0168* (0.0089)	0.0471*** (0.0076)
Network: s_{ecst}	0.0088*** (0.0020)	0.0282*** (0.0045)	0.0169*** (0.0064)	0.1012*** (0.0151)	0.0162 (0.0130)	0.0260*** (0.0087)
Observations	171,990	171,990	171,990	171,990	171,780	171,780
R-squared	0.5011	0.6302				
Ethnicity by County FE	Yes	Yes	Yes	Yes		Yes
Year by State FE	Yes	Yes	Yes	Yes	Yes	Yes
Ethn. by County time-linear trends		Yes		Yes		
First differences model					Yes	Yes

Standard errors clustered at ethnicity-by-county level in parentheses (***) $p < 0.01$, (**) $p < 0.05$, (*) $p < 0.1$

7 Robustness Checks

We perform two types of robustness checks on instruments' validity and possible omitted variables at county level that may be relevant during the period of US history covered by our analysis.

7.1 Tests for Instruments' Validity

The instrumental variables we have used in our analysis rely on the pre-settlement of co-ethnic immigrants to apportion aggregate inflows (shift-share approach) or supply shocks (quasi-experimental approach) across counties. Exclusion restrictions would be violated in the presence of any unobserved county-level shock affecting both immigrants' pre-settlements and immigrant inventors' outcomes. For example, productivity or labour demand shocks in one or more counties in 1870 may simultaneously attract immigrant workforce and stimulate innovation. If these shocks were serially correlated, the validity of the shift-share IV would be compromised.

We seek to account for unobserved county-level heterogeneity at the beginning of the period by performing a battery of tests for the validity of our instruments. In particular, we re-estimate (11) controlling for interactions between time dummies and the 1870 level of a set of county-level

variables, available in IPUMS NHGIS county-level Census file, that might be relevant for the initial geographical distribution of immigrants. Validity checks using the shift-share IVs are reported in Columns 1 to 3 of Table 7 for immigrant inventors’ presence and the corresponding columns of Table 8 for their productivity. Column 1 considers (log) population in 1870 to capture local labor market size as this may have attracted immigrants and also spurred innovation through knowledge agglomeration. Column 2 control for 1870 (log) output per capita in both farming and manufacturing sectors as higher productivity may be both a result and a driver of innovation. Moreover, by boosting local labor demand, economic development is a key factor shaping the concentration of immigrants. Finally, Column 3 controls for the illiteracy rate and the (log) distance (in Km) from the nearest College in 1870, with the aim of capturing a county’s human capital development. The results on immigrant inventors’ presence and productivity described in Section 6 are unaffected by the introduction of these controls.

Columns 4 to 6 repeat the same validity tests for WWI and quota IVs. Given our first differences specification, rather than adjusting for the level of control variables in 1870 as in the case of shift-share IVs, here we control for county-level differences between 1870 and 1910 before WWI and quota shocks. Tables 7 and 8 confirm again the positive effects of co-ethnic networks and diversity on immigrant inventors’ outcomes of Section 6.

7.2 Population Size and Frontier Exposure

During our period of analysis the population was still very unevenly distributed across the US. This was partly due to uneven local growth, but also by the westward movement of European settlers from the original Atlantic coast (XVII century) to the Far West (XIX century) until the expansion of the American frontier ended with the admission of the last remaining western territories as states in 1912. This expansion represented a crucial structural change in both population dynamics and culture. [Bazzi et al. \(2017\)](#) find that after more than a century counties with higher ‘frontier exposure’ (as measured by the number of years spent on the frontier) still show a higher degree of ‘individualism’ (as measured by negative attitudes towards redistribution, public spending and other social policies such as the Affordable Care Act and the minimum wage). They explain this pattern in terms of the selective migration to the frontier of people with higher self-reliance. The same would apply in general to counties with low population density.

As long as immigrants may fit the self-reliant type, immigrant inventors and all sort of other immigrants may have congregated in frontier or low-density counties for reasons unrelated to co-

Table 7: Migrant inventors' location choice. 2SLS estimates. Tests for instruments validity

	Shift-share IV			Quota and WWI IVs		
	(1) $\log(L)_{ecst}$	(2) $\log(L)_{ecst}$	(3) $\log(L)_{ecst}$	(4) $\Delta\log(L)_{ecst}$	(5) $\Delta\log(L)_{ecst}$	(6) $\Delta\log(L)_{ecst}$
Within Diversity: $Theil_{ecst}$	0.1220*** (0.0252)	0.0973*** (0.0254)	0.1405*** (0.0277)	0.1006*** (0.0142)	0.0976*** (0.0138)	0.0914*** (0.0131)
Between Diversity: s_{ecst}	0.3758*** (0.0526)	0.2887*** (0.0530)	0.4485*** (0.0590)	0.0792*** (0.0096)	0.0864*** (0.0099)	0.0755*** (0.0093)
Network: s_{ecst}	0.1514*** (0.0198)	0.1355*** (0.0196)	0.1658*** (0.0206)	0.0816*** (0.0186)	0.0841*** (0.0185)	0.0813*** (0.0185)
Observations	170,730	170,730	170,550	170,730	170,730	170,550
Ethnicity by County FE	Yes	Yes	Yes	Yes	Yes	Yes
Year by State FE	Yes	Yes	Yes	Yes	Yes	Yes
Ethn. by County time-linear trends	Yes	Yes	Yes			
First differences model				Yes	Yes	Yes
1870 log-population×year	Yes					
1870 log-p.c. output×year		Yes				
1870 literacy and college dist.×year			Yes			
1870-1910 diff. log-population×year				Yes		
1870-1900 diff. log-p.c output×year					Yes	
1870-1910 diff. literacy and college dist.×year						Yes

¹ Standard errors clustered at ethnicity-by-county level in parentheses (*** p<0.01, ** p<0.05, * p<0.1).

² Column 1 includes 1870 county's log-population interacted with year dummies; Column 2 considers 1870 county's log-per capita farm and manufacturing output interacted with year dummies; Column 3 controls for 1870 county's literacy level and the log-distance (km) from nearest college interacted with year dummies.

³ Columns 4 to 6 introduce the same set of controls in Columns 1 to 3 but considering the difference between 1870 and 1910, except for the output variables for which we consider the difference between 1870 and 1900, since these were not available in 1910 Census data file.

ethnic networks and diversity. Conversely, one could argue that immigrants and in particular immigrant inventors tend to prefer populous and urbanised areas. In the former case, the fact that low population density and frontier exposure are associated with both a more diverse population and more immigrant inventors implies a potential positive bias in our estimates. The latter case, the bias would be negative. So far, we have not included population size as a control in (6) as diversity itself may affect population growth via, for instance, output growth [Ager and Brückner \(2013\)](#). If this were so, population would be a 'bad control' as it would be directly affected by the treatment variable. Yet, in order to check the robustness of our earlier results, we now introduce a time-varying control for population here to compare counties with similar demographic size. Next, to control for frontier exposure, we use the same data as in [Bazzi et al. \(2017\)](#) to identify for each census year the counties with population density below two inhabitants per square mile. Differently from them, however, we do not consider the time invariant number of years a county was on the frontier, but rather the time-varying number of years since the county 'crossed' the

Table 8: Migrant inventors' productivity. 2SLS estimates. Tests for instruments validity

	Shift-share IV			Quota and WWI IVs		
	(1) $\log(T)_{ecst}$	(2) $\log(T)_{ecst}$	(3) $\log(T)_{ecst}$	(4) $\Delta\log(T)_{ecst}$	(5) $\Delta\log(T)_{ecst}$	(6) $\Delta\log(T)_{ecst}$
Within Diversity: $Theil_{ecst}$	0.0548*** (0.0209)	0.0426* (0.0220)	0.0656*** (0.0224)	0.0638*** (0.0131)	0.0599*** (0.0129)	0.0594*** (0.0126)
Between Diversity: s_{ecst}	0.1705*** (0.0381)	0.1316*** (0.0411)	0.2085*** (0.0417)	0.0463*** (0.0076)	0.0500*** (0.0078)	0.0434*** (0.0076)
Network: s_{ecst}	0.0910*** (0.0147)	0.0839*** (0.0150)	0.0984*** (0.0151)	0.0261*** (0.0089)	0.0274*** (0.0088)	0.0256*** (0.0088)
Observations	170,730	170,730	170,550	170,730	170,730	170,550
Ethnicity by County FE	Yes	Yes	Yes	Yes	Yes	Yes
Year by State FE	Yes	Yes	Yes	Yes	Yes	Yes
Ethn. by County time-linear trends	Yes	Yes	Yes			
First differences model				Yes	Yes	Yes
1870 log-population×year	Yes					
1870 log-p.c. output×year		Yes				
1870 literacy and college dist.×year			Yes			
1870-1910 diff. log-population×year				Yes		
1870-1900 diff. log-p.c output×year					Yes	
1870-1910 literacy and college dist.×year						Yes

¹ Standard errors clustered at ethnicity-by-county level in parentheses (***) $p < 0.01$, ** $p < 0.05$, * $p < 0.1$.

² Column 1 includes 1870 county's log-population interacted with year dummies; Column 2 considers 1870 county's log-per capita farm and manufacturing output interacted with year dummies; Column 3 controls for 1870 county's literacy level and the log-distance (km) from nearest college interacted with year dummies.

³ Columns 4 to 6 introduce the same set of controls in Columns 1 to 3 but considering the difference between 1870 and 1910, except for the output variables for which we consider the difference between 1870 and 1900, since these were not available in 1910 Census data file.

frontier. If, for example, a certain county crossed the frontier in 1860, then 40 years have elapsed since its frontier exposure in 1900.

Tables 9 and 10) report the new results for immigrant inventors' presence and productivity with log-population size and our time-varying frontier exposure as additional controls. The two tables confirm the positive effects of co-ethnic networks and diversity, both between and within, on immigrant inventors' outcomes of Section 6. We then also check whether the effects of co-ethnic networks and diversity are heterogeneous across population size classes by separately considering counties in different terciles of population in 1880. While OLS estimates remain positive for all terciles, most of the action in terms of co-ethnic networks and diversity causing immigrant inventors' presence (Table 11) and productivity (Table 12) seems to take place in the third tercile (Columns 7 to 9) consisting of counties with population above about 18,000 residents. In this tercile the point estimates for both co-ethnic networks and diversity are all positive and significant

also in 2SLS regressions. Differently, in the second tercile (Columns 4 to 6) with county population between about 10,000 and 18,000 thousands inhabitants, the 2SLS point estimates are positive but not significant for diversity with shift-share IVs and for co-ethnic networks with WWI- and quota-based IVs. Lastly, in the first tercile there is no evidence of any casual effects on either immigrant inventors' outcomes with both types of IVs.

Table 9: Migrant inventors' location choice. Estimates with population and years since exposure to frontier

	OLS		Shift-Share IV		Quota and WWI IVs	
	(1)	(2)	(3)	(4)	(5)	(6)
	$\log(L)_{ecst}$	$\log(L)_{ecst}$	$\log(L)_{ecst}$	$\log(L)_{ecst}$	$\Delta\log(L)_{ecst}$	$\Delta\log(L)_{ecst}$
Within Diversity: $Theil_{ecst}$	0.0099*** (0.0010)	0.0098*** (0.0010)	0.1542*** (0.0263)	0.1539*** (0.0263)	0.0965*** (0.0128)	0.0972*** (0.0129)
Between Diversity: s_{ecst}	0.0445*** (0.0046)	0.0445*** (0.0046)	0.4999*** (0.0624)	0.4984*** (0.0624)	0.0852*** (0.0095)	0.0856*** (0.0095)
Network: s_{ecst}	0.0608*** (0.0075)	0.0608*** (0.0075)	0.1759*** (0.0214)	0.1755*** (0.0213)	0.0833*** (0.0185)	0.0834*** (0.0185)
$\log(pop)_{cst}$	0.0261*** (0.0075)	0.0265*** (0.0075)	-0.1506*** (0.0242)	-0.1498*** (0.0243)	-0.0328*** (0.0089)	-0.0330*** (0.0089)
Years since exposure to frontier		0.0005*** (0.0002)		0.0003 (0.0002)		0.0004*** (0.0001)
Observations	171,990	171,990	171,990	171,990	171,780	171,780
R-squared	0.7197	0.7197				
Ethnicity by County FE	Yes	Yes	Yes	Yes	Yes	Yes
Year by State FE	Yes	Yes	Yes	Yes	Yes	Yes
Ethn. by County time-linear trends	Yes	Yes	Yes	Yes		
First differences model					Yes	Yes

¹ Standard errors clustered at ethnicity-by-county level in parentheses (***) $p < 0.01$, (**) $p < 0.05$, (*) $p < 0.1$.

² Columns 1, 3 and 5 include county's log-population. Columns 2, 4 and 6 add a control for frontier exposure, i.e. the number of years passed since the county was on either the eastern or western frontier.

8 Conclusions

Immigration policies favouring high-skilled arrivals while penalizing low-skilled ones rest on the implicit assumption that the supply of high-skilled immigrants is largely inelastic and high-skilled immigrants are indifferent to the presence of other immigrants. However, if this assumption failed and high-skilled immigrants valued the presence of other immigrants, harsh restrictions on low-skill inflows could end up discouraging the very same high-skilled inflows discriminatory policies are meant to target in the first place.

Table 10: Migrant inventors' productivity. Estimates with population and years since exposure to frontier

	OLS		Shift-Share IV		Quota and WWI IVs	
	(1)	(2)	(3)	(4)	(5)	(6)
	$\log(T)_{jcst}$	$\log(T)_{jcst}$	$\log(T)_{jcst}$	$\log(T)_{jcst}$	$\Delta\log(T)_{jcst}$	$\Delta\log(T)_{jcst}$
Within Diversity: $Theil_{-ecst}$	0.0061*** (0.0009)	0.0061*** (0.0009)	0.0693*** (0.0206)	0.0693*** (0.0206)	0.0590*** (0.0119)	0.0595*** (0.0119)
Between Diversity: s_{-ecst}	0.0241*** (0.0037)	0.0241*** (0.0037)	0.2280*** (0.0428)	0.2282*** (0.0429)	0.0482*** (0.0076)	0.0485*** (0.0076)
Network: s_{ecst}	0.0279*** (0.0046)	0.0279*** (0.0046)	0.1023*** (0.0152)	0.1024*** (0.0152)	0.0266*** (0.0088)	0.0267*** (0.0088)
$\log(pop)_{cst}$	0.0070 (0.0048)	0.0070 (0.0047)	-0.0734*** (0.0181)	-0.0735*** (0.0182)	-0.0217*** (0.0067)	-0.0219*** (0.0067)
Years since exposure to frontier		0.0001 (0.0002)		-0.0000 (0.0002)		0.0003*** (0.0001)
Observations	171,990	171,990	171,990	171,990	171,780	171,780
R-squared	0.6302	0.6302				
Ethnicity by County FE	Yes	Yes	Yes	Yes	Yes	Yes
Year by State FE	Yes	Yes	Yes	Yes	Yes	Yes
Ethn. by County time-linear trends	Yes	Yes	Yes	Yes		
First differences model					Yes	Yes

¹ Standard errors clustered at ethnicity-by-county level in parentheses (** p<0.01, * p<0.05, * p<0.1).

² Columns 1, 3 and 5 include county's log-population. Columns 2, 4 and 6 add a control for frontier exposure, i.e. the number of years passed since the county was on either the eastern or western frontier.

Table 11: Migrant inventors' location choice. Estimates by 1880 county population terciles

	1st tercile $pop_{c1880} \leq 9798$			2nd tercile $9806 \geq pop_{c1880} \leq 18831$			3rd tercile $pop_{c1880} \geq 18854$		
	(1)	(2)	(3)	(4)	(5)	(6)	(7)	(8)	(9)
	OLS	Shift-Share	Q. and WWI	OLS	Shift-Share	Q. and WWI	OLS	Shift-Share	Q. and WWI
	$\log(L)_{ecst}$	$\log(L)_{ecst}$	$\Delta\log(L)_{ecst}$	$\log(L)_{ecst}$	$\log(L)_{ecst}$	$\Delta\log(L)_{ecst}$	$\log(L)_{ecst}$	$\log(L)_{ecst}$	$\Delta\log(L)_{ecst}$
Within Diversity: $Theil_{-ecst}$	0.0029*** (0.0009)	-0.2642 (0.3582)	0.0208 (0.0135)	0.0015* (0.0008)	0.0411 (0.0350)	0.0706*** (0.0191)	0.0225*** (0.0035)	0.1480*** (0.0271)	0.0736*** (0.0279)
Between Diversity: s_{-ecst}	0.0083** (0.0037)	-0.5506 (0.7854)	0.0200 (0.0170)	0.0162*** (0.0059)	0.1245 (0.1277)	0.0463*** (0.0110)	0.1605*** (0.0164)	0.8205*** (0.0704)	0.1172*** (0.0138)
Network: s_{ecst}	0.0099* (0.0058)	-0.0563 (0.1650)	0.0040 (0.0261)	0.0274*** (0.0096)	0.0744** (0.0303)	0.0168 (0.0120)	0.1494*** (0.0168)	0.2691*** (0.0360)	0.1320*** (0.0202)
Observations	48,690	48,690	48,510	54,900	54,900	54,870	68,400	68,400	68,400
R-squared	0.4864			0.4086			0.7511		
Ethnicity by County FE	Yes	Yes	Yes	Yes	Yes	Yes	Yes	Yes	Yes
Year by State FE	Yes	Yes	Yes	Yes	Yes	Yes	Yes	Yes	Yes
Ethn. by County time-linear trends	Yes	Yes		Yes	Yes		Yes	Yes	
First differences model			Yes			Yes			Yes

Standard errors clustered at ethnicity-by-county level in parentheses (** p<0.01, * p<0.05, * p<0.1)

We have investigated the validity of the foregoing argument exploiting a decennial dataset on the US in the Age of Mass Migration from 1870 and 1940. the dataset contains about 43,000

Table 12: Migrant inventors' productivity. Estimates by 1880 county population terciles

	1st tercile $pop_{e1880} \leq 9798$			2nd tercile $9806 \geq pop_{e1880} \leq 18831$			3rd tercile $pop_{e1880} \geq 18854$		
	(1)	(2)	(3)	(4)	(5)	(6)	(7)	(8)	(9)
	OLS	Shift-Share	Q. and WWI	OLS	Shift-Share	Q. and WWI	OLS	Shift-Share	Q. and WWI
	$\log(T)_{jcst}$	$\log(T)_{jcst}$	$\Delta\log(Inv)_{ecst}$	$\log(T)_{ecst}$	$\log(T)_{ecst}$	$\Delta\log(Inv)_{ecst}$	$\log(T)_{ecst}$	$\log(T)_{ecst}$	$\Delta\log(Inv)_{ecst}$
Within Diversity: $Theil_{ecst}$	0.0026** (0.0010)	-0.4144 (0.5140)	0.0221 (0.0149)	0.0023** (0.0010)	0.0826 (0.0531)	0.0576*** (0.0171)	0.0116*** (0.0031)	0.0664*** (0.0210)	0.0280 (0.0254)
Between Diversity: s_{ecst}	0.0053 (0.0034)	-0.8615 (1.1306)	0.0182 (0.0168)	0.0092 (0.0070)	0.2253 (0.1802)	0.0338*** (0.0123)	0.0720*** (0.0110)	0.3231*** (0.0536)	0.0623*** (0.0112)
Network: s_{ecst}	0.0039 (0.0045)	-0.1319 (0.2343)	0.0116 (0.0242)	0.0223*** (0.0081)	0.0954** (0.0416)	0.0050 (0.0100)	0.0610*** (0.0098)	0.1325*** (0.0230)	0.0452*** (0.0084)
Observations	48,690	48,690	48,510	54,900	54,900	54,870	68,400	68,400	68,400
R-squared	0.4414			0.4444			0.6644		
Ethnicity by County FE	Yes	Yes	Yes	Yes	Yes	Yes	Yes	Yes	Yes
Year by State FE	Yes	Yes	Yes	Yes	Yes	Yes	Yes	Yes	Yes
Ethn. by County time-linear trends	Yes	Yes		Yes	Yes		Yes	Yes	
First differences model			Yes			Yes			Yes

Standard errors clustered at ethnicity-by-county level in parentheses (***) $p < 0.01$, (**) $p < 0.05$, (*) $p < 0.1$

patents granted to about 20,000 immigrants together with the patentees' counties of residence and ethnicity as reported in USPTO records. These pieces of information are matched with NHGIS IPUMS county-level decennial census files between 1870 and 1930. Exploiting variation across 2,900 counties and 15 ethnicities over time, we have looked at the impacts of local co-ethnic networks and diversity in each census year on the change in immigrant inventors' presence and productivity in the subsequent decade.

We have found that co-ethnic networks as well as 'between' and 'within' diversity act as significant pull factors for immigrant inventors. A model of immigrant inventors' location choices has allowed to identify the main channel through which those pull factor operate in externalities that foster inventors' productivity. Our findings are robust to checks of instruments' validity and to the inclusion of several control variables, including counties' population density and exposure to the American frontier. Though based on historical evidence, they are nonetheless relevant for today's advanced economies that have become major receivers of migrant flows and, in a long-term perspective, have started thinking about immigration not only in terms of its level but also in terms of its composition.

References

- Abramitzky, R., Ager, P., Boustan, L. P., Cohen, E., and Hansen, C. W. (2019). The effects of immigration on the economy: Lessons from the 1920s border closure. Technical report, National Bureau of Economic Research.
- Abramitzky, R. and Boustan, L. (2017). Immigration in american economic history. *Journal of economic literature*, 55(4):1311–45.
- Acemoglu, D. (2010). When does labor scarcity encourage innovation? *Journal of Political Economy*, 118(6):1037–1078.
- Ager, P. and Brückner, M. (2013). Cultural diversity and economic growth: Evidence from the us during the age of mass migration. *European Economic Review*, 64:76–97.
- Ager, P. and Hansen, C. W. (2017). Closing heaven’s door: Evidence from the 1920s u.s. immigration quota acts. *Discussion Papers 17-22, University of Copenhagen. Department of Economics*.
- Akcigit, U., Grigsby, J., and Nicholas, T. (2017a). Immigration and the rise of american ingenuity. *American Economic Review*, 64:76–97.
- Akcigit, U., Grigsby, J., and Nicholas, T. (2017b). The rise of american ingenuity: Innovation and inventors of the golden age. *National Bureau of Economic Research*, No. w23047.
- Alesina, A., Harnoss, J., and Rapoport, H. (2016). Birthplace diversity and economic prosperity. *Journal of Economic Growth*, page 1–38.
- Algan, Y. and Cahuc, P. (2010). Inherited trust and growth. *American Economic Review*, 100(5):2060–92.
- Bahar, D., Rapoport, H., and Turati, R. (2020). Birthplace diversity and economic complexity: Cross-country evidence. *Research Policy*, page 103991.
- Bandiera, O., Rasul, I., and Viarengo, M. (2013). The making of modern america: Migratory flows in the age of mass migration. *Journal of Development Economics*, 102:23–47.
- Bazzi, S., Fiszbein, M., and Gebresilasse, M. (2017). Frontier culture: The roots and persistence of " rugged individualism " in the united states. Technical report, National Bureau of Economic Research.
- Bergquist, C. W. (1984). *Labor in the Capitalist World-economy*, volume 7. Sage Publications, Inc.
- Bloom, N. and Van Reenen, J. (2007). Measuring and explaining management practices across firms and countries. *The quarterly journal of Economics*, 122(4):1351–1408.

- Boeheim, R., Horvath, G., and Mayr, K. (2012). Birthplace diversity of the workforce and productivity spill-overs in firms. *WIFO Working Papers*, 438.
- Card, D. (2001). Immigrant inflows, native outflows, and the local labor market impacts of higher immigration. *Journal of Labor Economics*, 19(1):22–64.
- Diodato, D., Morrison, A., and Petralia, S. (2018). Migration and invention in the age of mass migration. *Papers in Economic Geography 1835, Utrecht University, Department of Human Geography and Spatial Planning*.
- Docquier, F., Turati, R., Valette, J., and Vasilakis, C. (2018). Birthplace diversity and economic growth: Evidence from the us states in the post-world war ii period. *mimeo*.
- Doran, K. and Yoon, C. (2018). Immigration and invention: Evidence from the quota acts. *Unpublished manuscript, https://www3.nd.edu/~kdoran/Doran_Quotas.pdf*.
- Eckert, F., Gvirtz, A., Liang, J., and Peters, M. (2018). A consistent county-level crosswalk for us spatial data since 1790. Technical report, Working Paper.
- Gennaioli, N., La Porta, R., Lopez-de Silanes, F., and Shleifer, A. (2013). Human capital and regional development. *The Quarterly journal of economics*, 128(1):105–164.
- Giuliano, P. (2007). Living arrangements in western europe: Does cultural origin matter? *Journal of the European Economic Association*, 5(5):927–952.
- Glaeser, E. L. and Resseger, M. G. (2010). The complementarity between cities and skills. *Journal of Regional Science*, 50(1):221–244.
- Goldin, C. (1994). *The regulated economy: A historical approach to political economy*, chapter The political economy of immigration restriction in the united states,, page 223–258. University of Chicago Press.
- Goldsmith-Pinkham, P., Sorkin, I., and Swift, H. (2018). Bartik instruments: What, when, why, and how. Technical report, National Bureau of Economic Research.
- Hanushek, E. A. and Kimko, D. D. (2000). Schooling, labor-force quality, and the growth of nations. *American economic review*, 90(5):1184–1208.
- Hatton, T. J. and Williamson, J. G. (1998). *The age of mass migration: Causes and economic impact*. Oxford University Press on Demand.
- Hughes, T. P. (2004). *American genesis: a century of invention and technological enthusiasm, 1870-1970*. University of Chicago Press.
- Hunt, J. (2011). Which immigrants are most innovative and entrepreneurial? distinctions by entry visa. *Journal of Labor Economics*, 29(3):417–457.

- Jaeger, D. A., Ruist, J., and Stuhler, J. (2018). Shift-share instruments and the impact of immigration. Technical report, National Bureau of Economic Research.
- Jaffe, A. B., Lerner, J., and Stern, S. (2001). *Innovation policy and the economy*. Mit Press.
- Kahane, L., Longley, N., and Simmons, R. (2013). The effects of coworker heterogeneity on firm-level output: Assessing the impacts of cultural and language diversity in the national hockey league. *The Review of Economics and Statistics*, 95(1):302–314.
- Kemeny, T. (2017). Immigrant diversity and economic performance in cities. *International Regional Science Review*, 40(2):164–208.
- Kerr, S. P., Kerr, W., Özden, C., and Parsons, C. (2016). Global talent flows. *Journal of Economic Perspectives*, 30(4):83–106.
- Kerr, W. and Lincoln, W. F. (2010). The supply side of innovation: H-1b visa reforms and us ethnic invention. *Journal of Labor Economics*, 28(3):473–508.
- Kerr, W. R. (2018). Heterogeneous technology diffusion and ricardian trade patterns. *The World Bank Economic Review*, 32(1):163–182.
- Khan, B. Z. (2005). *The Democratization of Invention: patents and copyrights in American economic development, 1790-1920*. Cambridge University Press.
- Khan, Z. and Sokoloff, K. L. (2004). Institutions and democratic invention in 19th-century america: Evidence from " great inventors," 1790-1930. *American Economic Review*, 94(2):395–401.
- King, D. (2009). *Making Americans: Immigration, race, and the origins of the diverse democracy*. Harvard University Press.
- Manson, S., Schroeder, J., Van Riper, D., and Ruggles, S. (2019). Ipums national historical geographical information system: Version 14.0 [database]. ipums. *Institute for Social Research and Data Innovation. University of Minnesota*.
- McFadyen, A. (1936). Meet the champion inventors. *Popular Science*, 128(1).
- McKenzie, D. and Rapoport, H. (2007). Network effects and the dynamics of migration and inequality: theory and evidence from mexico. *Journal of development Economics*, 84(1):1–24.
- Mokyr, J. (2005). The intellectual origins of modern economic growth. *The Journal of Economic History*, 65(2):285–351.
- Mokyr, J. and Voth, H.-J. (2009). Understanding growth in early modern europe. *Cambridge Economic History of Europe*, 1:7–42.
- Moretti, E. (2012). *The New Geography of Jobs*. Houghton Mifflin Harcourt.
- Moser, P. and San, S. (2019). Immigration, science, and invention: Evidence from the 1920s quota acts. *Unpublished manuscript*.

- Moser, P., Voena, A., and Waldinger, F. (2014). German jewish émigrés and us invention. *The American Economic Review*, 104(10):3222–3255.
- Nicholas, T. (2010). The role of independent invention in us technological development, 1880–1930. *The Journal of Economic History*, 70(1):57–82.
- Ottaviano, G. and Peri, G. (2006). The economic value of cultural diversity: Evidence from u.s. cities. *Journal of Economic Geography*, 6(1):9–44.
- Ottaviano, G. I. and Peri, G. (2005). Cities and cultures. *Journal of Urban Economics*, 58(2):304–337.
- Ozgen, C., Peters, C., Niebuhr, A., Nijkamp, P., and Poot, J. (2014). Does cultural diversity of migrants employees affect innovation? *International Migration Review*, 48(9):377–416.
- Peri, G. (2016). Immigrants, productivity, and labor markets. *Journal of Economic Perspectives*, 30(4):3–30.
- Peri, G., Shih, K., and Sparber, C. (2015). Stem workers, h-1b visas and productivity in us cities. *Journal of Labor Economics*, 33(S1):S225–S255.
- Petralia, S., Balland, P.-A., and Rigby, D. L. (2016). Unveiling the geography of historical patents in the united states from 1836 to 1975. *Scientific data*, 3(1):1–14.
- Roback, J. (1982). Wages, rents, and the quality of life. *Journal of political Economy*, 90(6):1257–1278.
- Romer, P. M. (1990). Endogenous technological change. *Journal of political Economy*, 98(5, Part 2):S71–S102.
- Sanderson, E. and Windmeijer, F. (2016). A weak instrument f-test in linear iv models with multiple endogenous variables. *Journal of Econometrics*, 190(2):212–221.
- Sequeira, S., Nunn, N., and Qian, N. (2020). Immigrants and the making of america. *The Review of Economic Studies*, 87(1):382–419.
- Squicciarini, M. P. and Voigtländer, N. (2015). Human capital and industrialization: Evidence from the age of enlightenment. *The Quarterly Journal of Economics*, 130(4):1825–1883.
- Stock, J. H. and Yogo, M. (2002). Testing for weak instruments in linear iv regression. Technical report, National Bureau of Economic Research.
- Suedekum, J., Wolf, K., and Blien, U. (2014). Cultural diversity and local labour markets. *Regional Studies*, 48(1):173–191.
- Tabellini, M. (2020). Gifts of the immigrants, woes of the natives: Lessons from the age of mass migration. *The Review of Economic Studies*, 87(1):454–486.

Ueda, R. (1992). American national identity and race in immigrant generations: Reconsidering hansen's" law".

Zucker, L. G., Darby, M. R., and Armstrong, J. (1998). Geographically localized knowledge: spillovers or markets? *Economic Inquiry*, 36(1):65–86.